



User Manual

Milli-Q® Reference System



About this User Manual

Purpose This User Manual is intended for use with a Milli-Q[®] Reference Water Purification System.
This User Manual is a guide for use during the installation, normal operation and maintenance of a Milli-Q Reference Water Purification System. It is highly recommended to completely read this manual and to fully comprehend its contents before attempting installation, normal operation or maintenance of the Water Purification System.
If this User Manual is not the correct one for your Water Purification System, then please contact Millipore[®].

Terminology The term “Milli-Q Reference Water Purification System” is replaced by the term “System” for the remainder of this User Manual unless otherwise noted.

Document FTPF11373 - V 1.0, 02/2010

About Millipore[®]

Internet Site Address www.millipore.com/bioscience

Manufacturing Site Millipore SAS
67120 Molsheim
FRANCE

Legal Information

Notice

The information in this document is subject to change without notice and should not be construed as a commitment by Millipore Corporation. Millipore Corporation assumes no responsibility for any errors that might appear in this document. This manual is believed to be complete and accurate at the time of publication. In no event shall Millipore Corporation be liable for incidental or consequential damages in connection with or arising from the use of this manual.

We manufacture and sell water purification systems designed to produce pure or ultrapure water with specific characteristics ($\mu\text{S/cm}$, T, TOC, CFU/ml, Eu/ml) when it leaves the water purification system provided that the System is fed with water quality within specifications, and properly maintained as required by the supplier.

We do not warrant these systems for any specific applications. It is up to the end user to determine if the quality of the water produced by our systems matches his expectations, fits with norms/legal requirements and to bear responsibility resulting from the usage of the water.

Warranty

Millipore Corporation (“Millipore”) warrants its products will meet their applicable published specifications when used in accordance with their applicable instructions for a period of one year from shipment of the products. **MILLIPORE MAKES NO OTHER WARRANTY, EXPRESSED OR IMPLIED. THERE IS NO WARRANTY OF MERCHANTABILITY OR FITNESS FOR A PARTICULAR PURPOSE.** The warranty provided herein and the data, specifications and descriptions of Millipore products appearing in Millipore’s published catalogues and product Literature may not be altered except by express written agreement signed by an officer of Millipore. Representations, oral or written, which are inconsistent with this warranty or such publications are not authorized and if given, should not be relied upon. In the event of a breach of the foregoing warranty, Millipore’s sole obligation shall be to repair or replace, at its option, the applicable product or part thereof, provided the customer notifies Millipore promptly of any such breach. If after exercising reasonable efforts, Millipore is unable to repair or replace the product or part, then Millipore shall refund to the customer all monies paid for such applicable product or part. **MILLIPORE SHALL NOT BE LIABLE FOR CONSEQUENTIAL, INCIDENTAL, SPECIAL OR ANY OTHER INDIRECT DAMAGES RESULTING FROM ECONOMIC LOSS OR PROPERTY DAMAGE SUSTAINED BY ANY CUSTOMER FROM THE USE OF ITS PRODUCTS.**

Continued on next page

Legal Information Continued

Trademarks Millipore, Elix, Q-Gard, Quantum, Milli-Q, BioPak, EDS-Pak, Millipak and Millipore Express are registered trademarks of Millipore Corporation. The “M” Mark and RiOs are trademarks of Millipore Corporation. All other trademarks are trademarks of their respective manufacturers.







Copyright © 2009 MILLIPORE CORPORATION. PRINTED IN FRANCE. ALL RIGHTS RESERVED. THIS BOOK OR PARTS THEREOF MAY NOT BE REPRODUCED IN ANY FORM WITHOUT THE WRITTEN PERMISSION OF THE PUBLISHERS

Safety Information

Statement

Your Milli-Q System should be installed and operated according to the instructions in this manual.
In particular, the hydraulic and electrical specifications should be followed and met.
It is important to use this equipment as specified in this manual; using this equipment in a different manner may impair the safety precautions of the Milli-Q System.

Symbols

Symbol	Meaning
	This <u>HAZARD</u> symbol is used to refer to instructions in this manual that need to be done safely and carefully.
	This <u>ATTENTION</u> symbol is used to refer to instructions in this manual that need to be done carefully.
	This <u>UV RADIATION</u> sticker is used to refer to a position on the Milli-Q System Cabinet or inside of it where exposure to UV light is possible.
	This <u>DANGER</u> sticker is used to refer to a position on the Milli-Q System Cabinet or inside of it that could be hazardous.
	This <u>ELECTRICAL GROUND</u> sticker is used to refer to a position on the Milli-Q System Cabinet or inside where an electrical ground connection is made.
	This <u>ELECTRICAL DANGER</u> sticker is used to refer to a position on the Milli-Q System Cabinet or inside where an electrical danger could exist.



Do not remove the covers of the Milli-Q System at any time.
Electrical and mechanical components inside the Milli-Q System could pose a hazard.
A qualified Millipore Service Representative should perform any work that needs to be done while the Milli-Q System is opened.

Table of Contents

Product Information	8
Overview	8
Cabinet	9
Consumables	14
Specifications and requirements.....	16
Installation.....	19
Overview	19
Alarms generated during installation	20
POD Unit, tubing and power cord.....	21
Installing the Q-Gard Pack.....	24
Rinsing the System.....	27
Installing a POD Pak	29
Registering UV Lamp timer	31
Calibrating the Flowrate.....	33
Software	35
Overview	35
Software Map	36
Standby Mode	37
General information	37
Description of Standby Menu	38
Manager Menu	40
Description	40
Ready Mode	43
General information	43
Description of Ready Menu	44
Using the Milli-Q System	47
Overview	47
Dispensing water	48
Viewing water quality	51
Viewing Operation	52
Viewing Consumable Status	54
Calling Millipore	55
Viewing Information	56
Maintenance	58
Overview	58
Maintenance Schedule.....	59
Replacing the Q-Gard Pack.....	60
Replacing the Quantum Cartridge.....	63
Replacing a POD Pak.....	67
Cleaning the Inlet Strainer.....	70
Calibrating the Flowrate.....	73

Alarms	74
Overview	74
Alarm Information.....	75
Summary of Alarm messages.....	79
Alerts	81
Overview	81
Alert information.....	82
Summary of Alert messages.....	87
Ordering Information	89
Consumables, Accessories and Systems	89

Product Information

Overview

Purpose

This chapter contains topics related to the System.

Some of the more important topics in this chapter are:

- installation requirements,
 - consumable information, and
 - dimensions of various components of the System
-

Contents

This chapter contains the following topics:

Topic	See Page
Cabinet	9
Consumables	14
Specifications and requirements	16

Cabinet

Overview

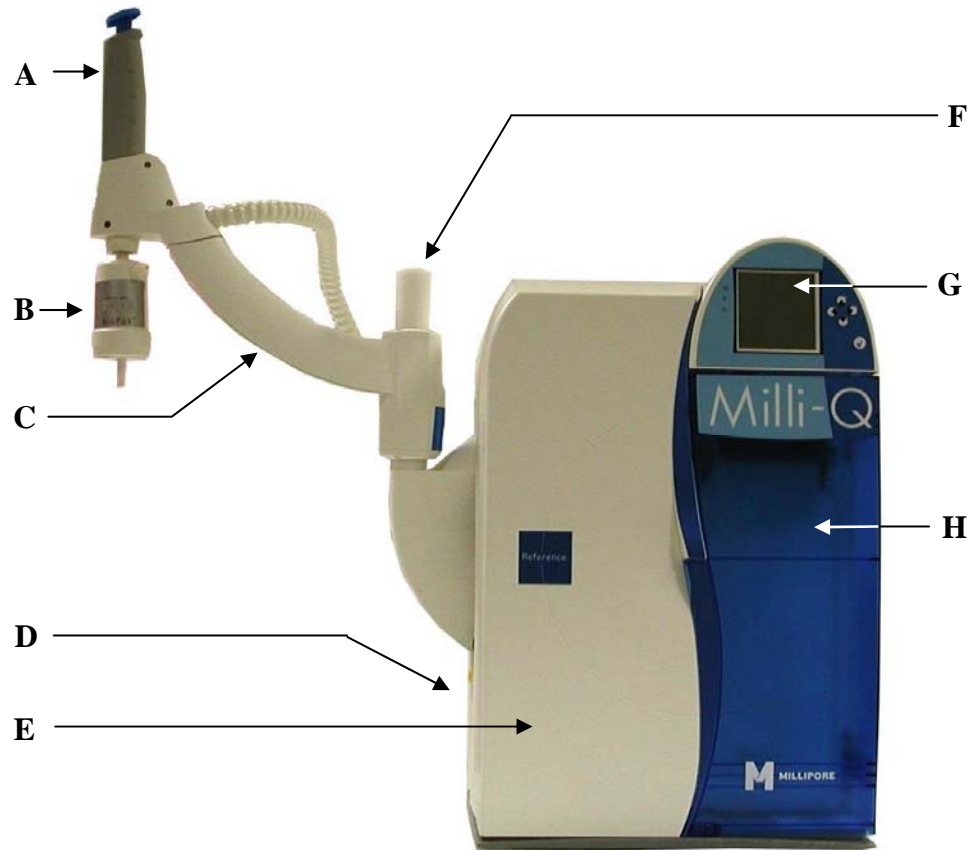

Item	Description/Name
A	Point Of Delivery (POD)
B	POD Pak
C	POD Arm
D	Connections for tubings, power cord, level sensor and other cables
E	Q-Gard [®] Pack
F	POD Mast
G	Main Display
H	Quantum [®] Cartridge

Main Display function

The Main Display is used to navigate the System software.

Continued on next page

Cabinet, Continued

Details of the Main Display

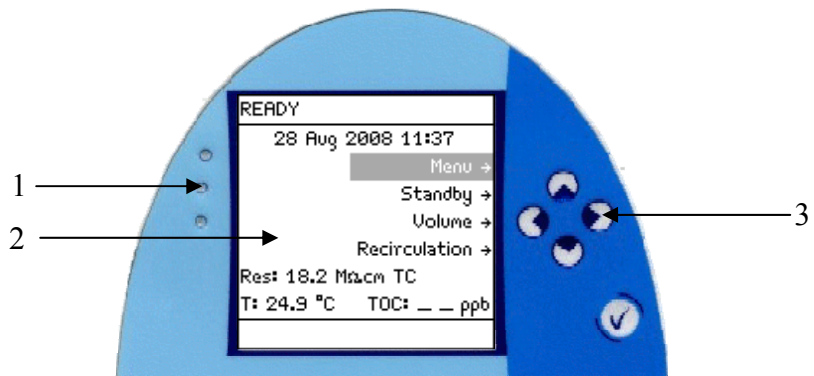

Item	Description
1	LEDs
2	Main LCD
3	Main Keypad



Right

The use of the Right Keypad button is shown below. It is used to move to the next screen.

In this example, the system is changed from STANDBY Mode to READY Mode.

Diagram 1	Action	Diagram 2
	<p>Press .</p>	



Left

The use of the Left Keypad button is shown below. It is used to move to the former screen.

Diagram 1	Action	Diagram 2
	<p>Press .</p>	

Continued on next page

Cabinet, Continued



Up

The use of the Up Keypad button is shown below. It is used to scroll up in a menu.

Diagram 1	Action	Diagram 2
<pre> READY 05 Dec 2008 09:40 Menu → Standby → Volume → Recirculation → Res: 18.2 MΩcm TC T: 24.9 °C TOC: _ _ ppb </pre>	<p>Press .</p>	<pre> READY 05 Dec 2008 09:40 Menu → Standby → Volume → Recirculation → Res: 18.2 MΩcm TC T: 24.9 °C TOC: _ _ ppb </pre>



Down

The use of the Down Keypad button is shown below. It is used to scroll down in a menu.

Diagram 1	Action	Diagram 2
<pre> READY 05 Dec 2008 09:40 Menu → Standby → Volume → Recirculation → Res: 18.2 MΩcm TC T: 24.9 °C TOC: _ _ ppb </pre>	<p>Press .</p>	<pre> READY 05 Dec 2008 09:40 Menu → Standby → Volume → Recirculation → Res: 18.2 MΩcm TC T: 24.9 °C TOC: _ _ ppb </pre>



Validate

The use of the Validate Keypad button is shown below. It is used to confirm a parameter modification.

Diagram 1	Action	Diagram 2
<pre> MILLI-Q PRODUCT RES Milli-Q Product Resistivity Setpoint : 16.5 MΩcm TC Press + and + to adjust. Press ✓ to validate. Press ← to exit. </pre>	<p>Press .</p>	<pre> SET POINTS Strainer Frequency → Milli-Q Feed Cond → Milli-Q Inter Res → Milli-Q Product Res → Milli-Q Product TOC → Millipak → BioPak → </pre>

Continued on next page

Cabinet, Continued

READY Mode – water quality values

The READY Mode screen display is explained below.

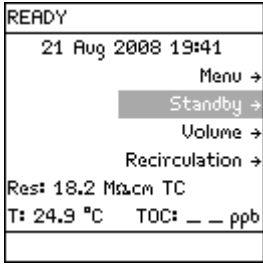
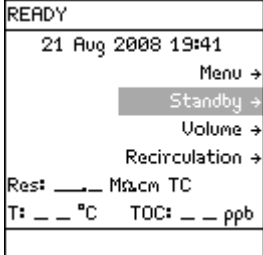
Diagram	Explanation
 <p>READY 21 Aug 2008 19:41 Menu → Standby → Volume → Recirculation → Res: 18.2 MΩ.cm TC T: 24.9 °C TOC: _ _ ppb</p>	<p>In this example, the water dispensed from the POD Unit has:</p> <ul style="list-style-type: none"> • a resistivity of 18.2 MΩ.cm, • is temperature compensated (TC) at 25°C, • a temperature of 24.9°C, and • the TOC value is: <ul style="list-style-type: none"> – not indicated with a Milli-Q Reference System, and – indicated with a Milli-Q Reference C+ System. <p>NOTE: This Milli-Q Reference System does not have a built-in TOC indicator and therefore does not display a TOC value. Should you wish to have a display of the TOC value, please contact Millipore and inquire about availability of the TOC Indicator Upgrade Kit.</p>
 <p>READY 21 Aug 2008 19:41 Menu → Standby → Volume → Recirculation → Res: _ _ MΩ.cm TC T: _ _ °C TOC: _ _ ppb</p>	<p>In this example, there are no water quality measurements to display. The water quality is only displayed when it is actually measured during water delivery or recirculation.</p>

LEDs

The LEDs are described below.

Item	Description
Green LED	System is operating within specifications.
Yellow LED	An Alert is present.
Red LED	An Alarm is present.

NOTE:

If an Alarm and an Alert are present at the same time, then only the red LED is lit.

The red and yellow LEDs are never lit at the same time.

Continued on next page

Cabinet, Continued

Port and cables The port and cable connections are explained below.

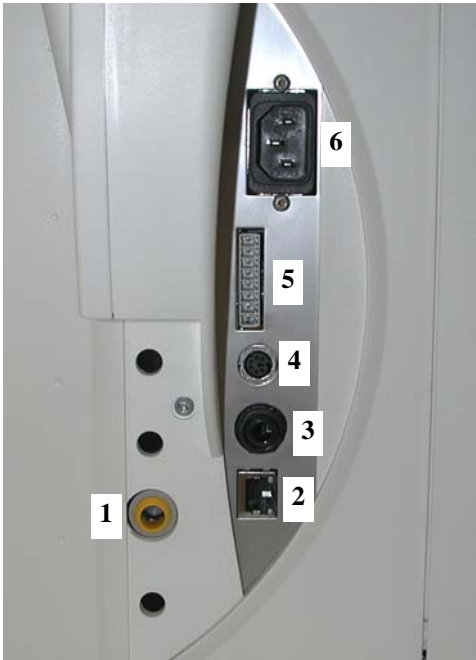

Item	Description	Item	Description
1	Feedwater port	4	Termination Plug connection (maximum 5 VDC)
2	Ethernet connection (maximum 5 VDC)	5	Accessories connection (maximum 24 VDC)
3	Level Sensor (maximum 5 VDC)	6	Power Entry connection (100-240 VAC)

Consumables

Flow diagram The water flow through a System is shown here in a flow diagram. The various consumables are described below.

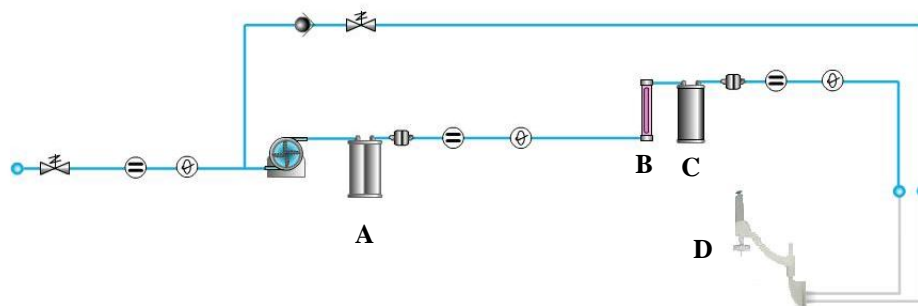

Item	Description
A	Q-Gard Pack
B	UV 185 nm Lamp
C	Quantum Cartridge
D	POD Pak

Q-Gard Pack The Q-Gard Pack is used to remove ions and organic molecules from the feedwater.

Item	Description
Q-Gard T1 Pack	The Q-Gard T1 Pack is used when the feedwater comes from RO, distillation or Electrodeionisation (EDI). An example of RO or EDI feedwater is the water coming from either a Millipore RiOs™ System or Elix® Water Purification System. This type of feedwater typically has some ions but contains little organic, particulate and colloidal contamination.
Q-Gard T2 Pack	The Q-Gard T2 Pack is used whenever the feedwater comes from a source other than mentioned above and has a Fouling Index ≤ 5 .
Q-Gard T3 Pack	The Q-Gard T3 Pack is used whenever the feedwater comes from a source other than mentioned above and has a Fouling Index > 5 .

UV 185 nm Lamp The dual wavelength UV 185 nm Lamp emits light at 185 nm and at 254 nm. The UV 185 nm Lamp kills bacteria and reduces the level of organic molecules in the water.

Continued on next page

Consumables, Continued

Quantum Cartridge

The Quantum Cartridge removes trace levels of ions and organic molecules.

Item	Description
Quantum TIX Cartridge	The Quantum TIX Cartridge contains only ion exchange resin. This type of Quantum Cartridge is used when maintaining absolutely trace levels of ions is critical.
Quantum TEX Cartridge	The Quantum TEX Cartridge contains ion exchange resin and synthetic carbon. These purification media are used when the Milli-Q [®] Water needs to have both trace levels of ions and trace levels of organic molecules.

POD Pak

The POD Pak is the final water purification device. It is attached to the Point of Delivery outlet. The POD Pak provides additional quality and insurance that trace contaminants related to specific applications are removed just before ultrapure water is delivered.

Specifications and requirements

Milli-Q® Water quality The water delivered from a POD Unit has the following characteristics.

Parameter	Specification	Units
Resistivity	18.2	MΩ.cm @25°C
TOC	≤ 5	ppb
Particulates > 0.22 μm**	< 1	Particulates/mL
Bacteria**	< 0.1	cfu/mL
Pyrogens*	< 0.001	Eu/mL
RNases*	< 0.01	ng/mL
DNases*	< 4	pg/μL
Flow Rate**	0.05 – 2	L/min

(*) With BioPak® Final Filter

(**) With Millipak® or BioPak Final Filter

NOTE:

These specifications are valid for Elix water feed within specification and for routine operation. Some specifications may not be achieved at start-up.

Weight

The various weights are found in the table below.

Item	Operating Weight	Dry Weight	Shipping Weight
Milli-Q Reference System	19.5 kg	14.5 kg	19 kg

Electrical

The electrical specifications and data are found in the table below.

Parameter	Value
Voltage	100-230 VAC ±10%
Frequency	50-60 Hz ±10%
Main Fuse	3.15 Amp Fast Acting; 5 mm x 20 mm; 250 V safety voltage. The fuse should be serviced by a qualified Millipore Service Representative.
Power Used	125 VA
Power Cord Length	2.5 metres
Electrical Ground	Earth Grounded
Power Cord use	The System is powered on and off by removing the power cord from the wall outlet. The power cord should be plugged into a wall outlet that is accessible.

Continued on next page

Specifications and requirements, Continued

Dimensions

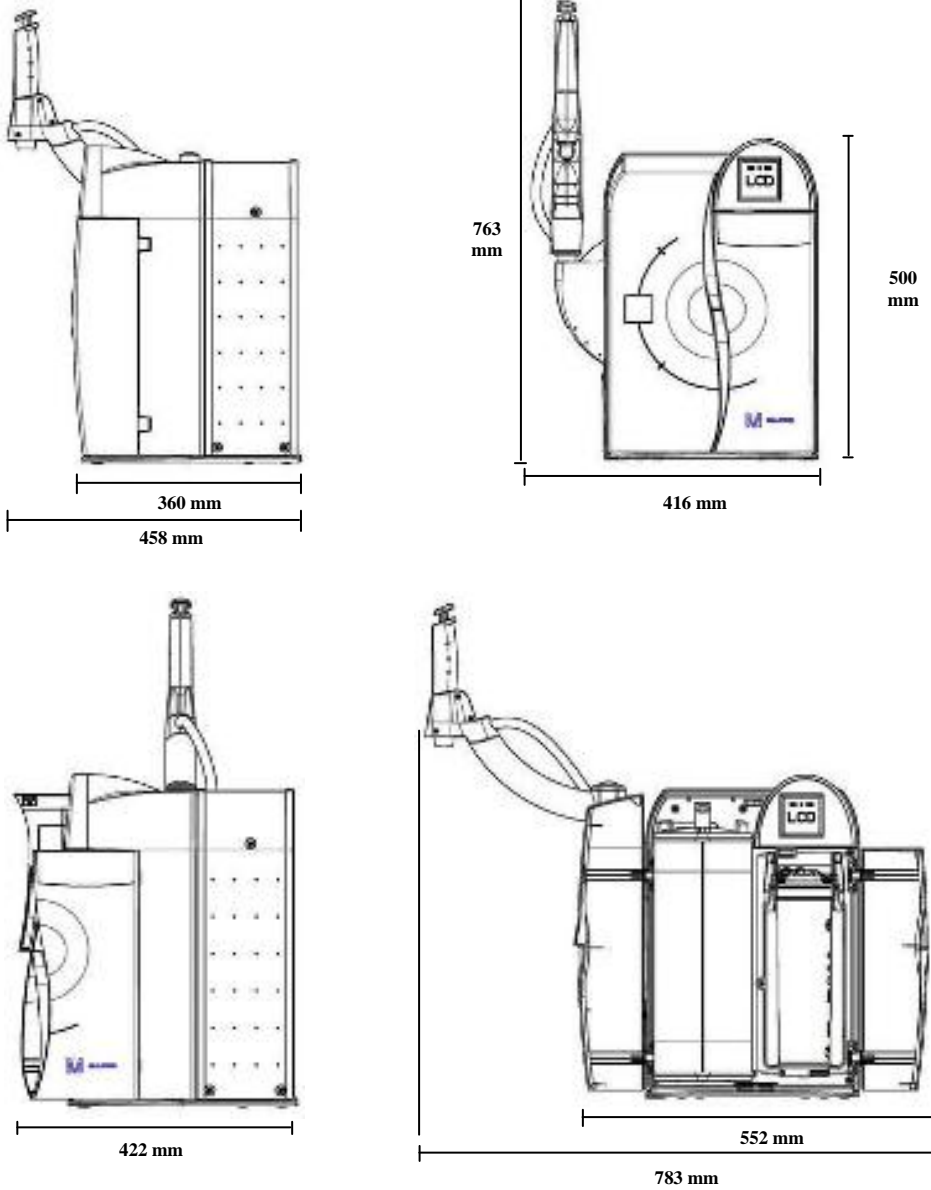

Materials of construction

Please contact Millipore for a list of the Materials of Construction.

Continued on next page

Specifications and requirements, Continued

Feedwater The Feedwater requirements are listed here.

Parameter	Value
Type	Pre-treated water including one or several of the following technologies: <ul style="list-style-type: none"> • RO • RO + EDI • RO + DI • Distillation, and • DI.
Conductivity	< 100 μ S/cm @ 25°C
Pressure	0 bar < P < 0.3 bar
Temperature	5°C < T < 35°C
Maximum TOC	< 50 ppb
Fouling Index	< 5
pH	4 < pH < 10

Environmental The Environmental requirements are listed here.

Parameter	Value
Altitude	< 3000 metres
Ambient operating temperature	4 – 40°C
Ambient storage temperature	4 – 40°C
Installation Category	II
Location	The System is intended for indoor use only.
Pollution Degree	2
Relative humidity during storage and operation	Maximum relative humidity 80% for temperatures up to 31°C decreasing linearly to 50% relative humidity at 40°C.

Noise Level The noise level is < 50 dB at a distance of 1 metre.

Consumables The minimum consumables required for installation are listed here. Note that these items are not shipped with the System and must be ordered separately:

- Q-Gard Pack,
- Quantum Cartridge, and
- POD Pak.

Installation

Overview

Purpose This chapter explains how to install the System.

Contents This chapter contains the following topics:

Topic	See Page
Alarms generated during installation	20
POD Unit, tubing and power cord	21
Installing the Q-Gard Pack	24
Rinsing the System	27
Installing a POD Pak	29
Registering UV Lamp timer	31
Calibrating the Flowrate	33

Summary list The steps shown below outline the sequence and major actions of a System installation. Please refer to this list throughout the installation.

Step	Action
1	Put POD Arm onto POD Mast
2	Put Point Of Delivery onto POD Arm
3	Install feedwater tubing, termination plug and power cord
4	Power on the System, check date and time
5	Install, flush and rinse the Q-Gard Pack and the Quantum Cartridge
6	Install and Register the POD Pak
7	Register the UV Lamp timer
8	Calibrate the Product Water flowrate

Alarms generated during installation

Overview

During the installation of a System, certain Alarm messages are generated. This occurs because:

- there is air in the:
 - tubings,
 - Q-Gard Pack, and
 - Quantum Cartridge.
- the Q-Gard Pack is not installed, and
- the Quantum Cartridge is not installed.

These alarms are explained here. The ways to cancel them are explained also. For more information about Alarm messages, see the chapter titled ‘Alarms’.



It is perfectly normal to see alarms during installation.

The System is designed to use various sensors to alert you of problems during normal operation of the system. This insures optimal water quality.

During installation, these sensors are active. As a result, it is possible to have alarms generated. In order to advance during the installation, these alarms should be cancelled for a limited time.

Q-GARD PACK OUT message

This alarm occurs because the Q-Gard Pack is not installed.

This alarm goes away when the Q-Gard Pack is detected by the System.

To cancel the text display of this alarm message, follow the instructions on the LCD.

QUANTUM CARTRIDGE OUT message

This alarm occurs because the Quantum Cartridge is not installed.

This alarm goes away when the Quantum Cartridge is detected by the System.

To cancel the text display of this alarm message, follow the instructions on the LCD.

MILLI-Q RES < SP, REPLACE Q-GARD and QUANTUM message

This alarm occurs because the Quantum Cartridge is not fully rinsed out or there is air in the tubing near a resistivity sensor.

This alarm goes away when a few litres of water are dispensed from the POD Unit.

To cancel the text display of this alarm message, follow the instructions on the LCD.

POD Unit, tubing and power cord

Separate POD Arm and Point Of Delivery

Separate the POD Arm and the Point Of Delivery by cutting and removing the tape that holds them together.

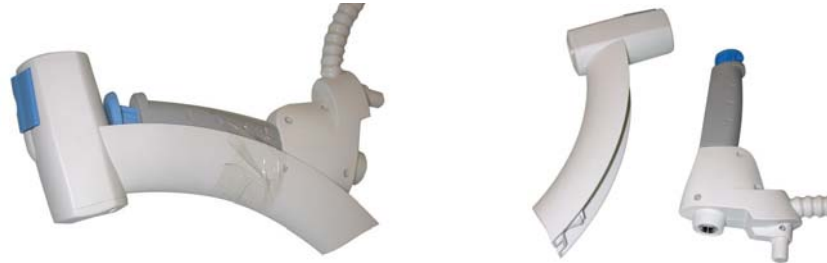

POD Arm

Place the POD and POD Arm onto the POD Mast as shown below.

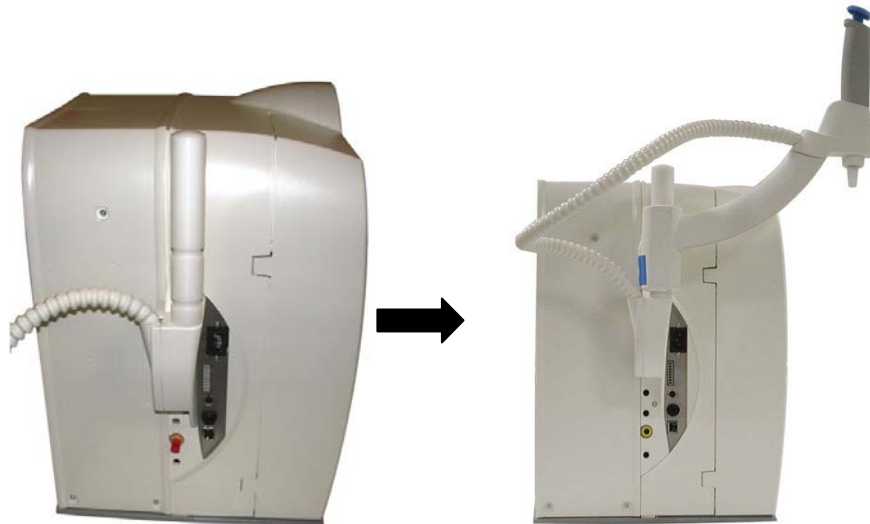

Feedwater tubing

The Feedwater tubing is connected to either a:

- Reservoir, or
 - Loop (pipe end)
-

Reservoir

Connect the feedwater tubing according to the specifications supplied with the Reservoir.

Continued on next page

POD Unit, tubing and power cord, Continued

Loop

- Install the Inlet Strainer as shown here.
- Connect one end of the feedwater tubing to the Inlet Strainer.

NOTE:

- A pressure regulator is normally required after the Inlet Strainer.

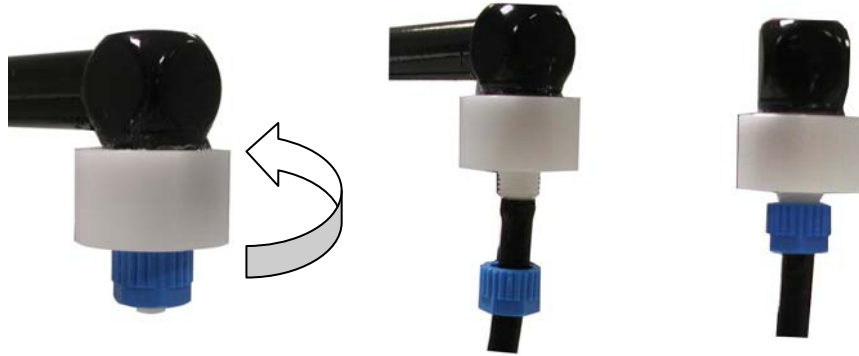

Connections to System Cabinet

Follow the steps below.

Step	Action	Diagram
1	Plug one end of the feedwater tubing to the Cabinet. Open the valve on the other end of the feedwater tubing to allow water flow later.	
2	Plug in the Termination Plug.  It must be plugged in before the power cord.	
3	Plug in the power cord. The Main Display goes through a series of start up screens.	
4	Wait for the Main Display to show a STANDBY Mode screen. This may take up to a few minutes.	

Continued on next page

POD Unit, tubing and power cord, Continued

Alarm messages

Because the System is starting without a Q-Gard Pack or a Quantum Cartridge installed, there are alarm messages displayed.

These alarms are:

- Q-GARD PACK OUT, and
- QUANTUM CARTRIDGE OUT.

NOTE:

The TANK EMPTY Alarm message is shown if the System is configured to have a Level Sensor.

Cancel Alarms

When an Alarm message is displayed, follow the instructions on the screen to cancel the text display of the Alarm.

Check the date

When the Alarm messages are cancelled, check that the displayed date is correct.





If necessary, go to the Manager Menu Software and correct the date and time. See the [Software Map](#) in the beginning of the Software Chapter for more information.



Do not install a Q-Gard Pack or a Quantum Cartridge until the displayed date is correct.

Installing the Q-Gard Pack



Procedure Follow the steps below to install a new Q-Gard Pack.

Step	Action	Diagram
1	Start in STANDBY Mode. NOTE: The Q-GARD PACK OUT Alarm message is not shown at this time. By following the instructions earlier in this manual, the alarm was cancelled.	
2	Open the left door of the System Cabinet. Remove the 2 protective caps located on the ports inside.	
3	Remove the covers on the 2 ports of the Q-Gard Pack. Make sure the rubber O-rings are firmly in place. Wet the O-rings with water.	
4	Push the top of the Q-Gard Pack into the ports on the System.	

Continued on next page







Installing the Q-Gard Pack, Continued

Procedure
(continued)

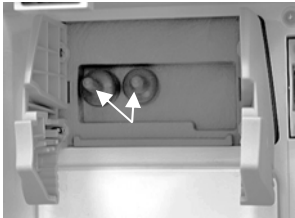
Step	Action	Diagram	
5	Push the bottom of the Q-Gard Pack inwards.		
6	Push the pack locking handle down. Close the left door.		
7	One minute later, the Main LCD shows that a new Q-Gard Pack is installed.	<table border="1" data-bbox="1075 1196 1337 1458"> <tr> <td data-bbox="1075 1196 1337 1458"> <p>INSTALL Q-GARD</p> <p>A new Q-Gard T1 has been installed.</p> <p>Catalogue N° : QGARDT1X1</p> <p>Lot N° : F6DN27329. ←</p> </td> </tr> </table>	<p>INSTALL Q-GARD</p> <p>A new Q-Gard T1 has been installed.</p> <p>Catalogue N° : QGARDT1X1</p> <p>Lot N° : F6DN27329. ←</p>
<p>INSTALL Q-GARD</p> <p>A new Q-Gard T1 has been installed.</p> <p>Catalogue N° : QGARDT1X1</p> <p>Lot N° : F6DN27329. ←</p>			
8	Press  .	<table border="1" data-bbox="1075 1471 1337 1733"> <tr> <td data-bbox="1075 1471 1337 1733"> <p>STANDBY</p> <p>20 Aug 2008 22:48</p> <p>Menu →</p> <p>Ready →</p> </td> </tr> </table>	<p>STANDBY</p> <p>20 Aug 2008 22:48</p> <p>Menu →</p> <p>Ready →</p>
<p>STANDBY</p> <p>20 Aug 2008 22:48</p> <p>Menu →</p> <p>Ready →</p>			



Installing the Quantum Cartridge

Procedure Follow the steps below to install a new Quantum Cartridge.

Step	Action	Diagram
1	Open the right door of the System Cabinet. Remove the 2 protective caps located on the ports inside.	
2	Remove the covers on the 2 ports of the Quantum Cartridge. Wet the O-rings with water.	
3	Install the Quantum Cartridge until it is fully seated. Close the right door.	
4	One minute later, the Main LCD shows that a new Quantum Cartridge is installed.	
5	Press  .	

Rinsing the System

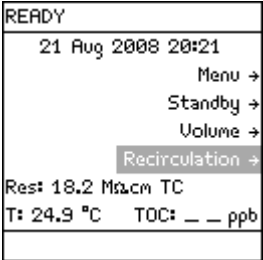
Procedure Follow the steps below to rinse the System.

Step	Action	Diagram
1	<p>Locate the clear tubing and the barbed fitting from the System Accessories Bag. Screw the barbed fitting onto the POD Unit. Push one end of the clear tubing onto the end of the barbed fitting. Place the other end of the clear tubing into a sink.</p> <p>NOTE: Do not use any white tape on the threads of the barbed fitting. An O-ring located inside the POD Dispenser ensures water tightness.</p>	
2	Place the System into READY Mode.	
3	Push the POD Plunger all the way down and then release it. In a few minutes, water should come out of the POD Unit.	
4	Dispense water for at least 10 minutes.	

Continued on next page

Rinsing the System, Continued

Procedure
(continued)

Step	Action	Diagram
5	Push the POD Plunger all the way down and then release it to stop dispensing water. Leave the System in READY Mode.	

Installing a POD Pak

Overview

The installation of a POD Pak involves 2 steps. These are:







- placing and flushing the POD Pak onto the POD Unit, and
- registering the installation of a specific POD Pak.

Placing and flushing

Follow the instructions delivered with the POD Pak.

Registering













Follow the steps below to register the installation of the POD Pak.

Step	Action	Diagram
1	Start in STANDBY Mode.	
2	Select Menu. Press  .	
3	Select Maintenance. Press  .	
4	Scroll down to Install POD Pak. Select it.	

Continued on next page

Installing a POD Pak, Continued

Registering (continued)

Step	Action	Diagram
5	Press  .	
6	Press  .	
7	In this example, you choose Millipak. Press  .	
8	Press  .	
9	Press  .	
10	Press 3 times on  .	

Registering UV Lamp timer

Introduction

The timer used for the UV 185 nm Lamp must be reset when the System is installed.







If this is not done, then the message indicating that a Lamp replacement is needed is shown too early.

NOTE:

Before doing this, make sure that the date and time have been checked for accuracy.

Procedure





This procedure shows how to reset the timer used for the UV 185 nm Lamp.

Step	Action	Diagram
1	Place the System in STANDBY Mode.	
2	Select Menu. Press  .	
3	Select Maintenance. Press  .	
4	Select Install UV 185 nm Lamp. Press  .	

Continued on next page

Registering UV Lamp timer, Continued







Procedure
(continued)

Step	Action	Diagram
5	Press  .	<div style="border: 1px solid black; padding: 5px;"> <p>INSTALL UV 185 LAMP</p> <p>This procedure should be performed by a Millipore trained service engineer. Press → to continue or ← to exit.</p> </div>
6	Press  .	<div style="border: 1px solid black; padding: 5px;"> <p>INSTALL UV 185 LAMP</p> <p>The Millipore trained service engineer confirms the UV 185 nm Lamp installation by pressing ✓. Press ← to exit.</p> </div>
7	Press  .	<div style="border: 1px solid black; padding: 5px;"> <p>INSTALL UV 185 LAMP</p> <p>UV 185 nm Lamp installation is registered. Next maintenance in 730 days. Press ← to exit.</p> </div>
8	Press 3 times on  .	<div style="border: 1px solid black; padding: 5px;"> <p>STANDBY</p> <p>21 Aug 2008 21:48</p> <p style="text-align: right;">Menu →</p> <p style="text-align: right;">Ready →</p> </div>

Calibrating the Flowrate

Introduction The Milli-Q Water flowrate should be calibrated when the System is installed. A 1 Litre graduated cylinder is needed.

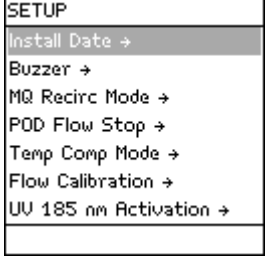

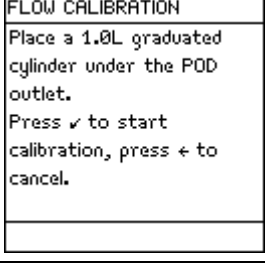









Procedure Follow the steps below to perform a Flow Calibration.

Step	Action	Diagram
1	Go to STANDBY Mode.	
2	Select Menu. Press  .	
3	Enter the Manager Menu. See the Software Chapter to learn how to enter the Manager Menu.	
4	Select Setup. Press  .	
5	Select Flow Calibration. Press  .	

Continued on next page

Calibrating the Flowrate, Continued

Procedure (continued)

Step	Action	Diagram
6	Place a 1 L Graduated Cylinder under the POD Unit. Press  .	<div style="border: 1px solid black; padding: 5px;"> <p>FLOW CALIBRATION</p> <p>Press  or press  on the Q-POD keypad if you have installed one to start water delivery.</p> <p>After the water dispensing is complete, measure the collected volume.</p> </div>
7	Press  .	<div style="border: 1px solid black; padding: 5px;"> <p>FLOW CALIBRATION</p> <p>The system is now delivering water.</p> <p>Task Completion: XX %</p> </div>
8	Water dispenses automatically from the POD Unit. Wait until it stops dispensing water.	<div style="border: 1px solid black; padding: 5px;"> <p>FLOW CALIBRATION</p> <p>Volume : 900 mL</p> <p>Use  and  keys to register the value of the collected volume. Press  to confirm and exit.</p> </div>
9	Measure the amount of water (in ml) that was dispensed. Suppose 870 ml was collected. Input this using the Keypad.	<div style="border: 1px solid black; padding: 5px;"> <p>FLOW CALIBRATION</p> <p>Volume : 870 mL</p> <p>Use  and  keys to register the value of the collected volume. Press  to confirm and exit.</p> </div>
10	Perform again the flow calibration to improve accuracy. Press  .	<div style="border: 1px solid black; padding: 5px;"> <p>SETUP</p> <p>Install Date →</p> <p>Buzzer →</p> <p>MQ Recirc Mode →</p> <p>POD Flow Stop →</p> <p>Temp Comp Mode →</p> <p>Flow Calibration →</p> <p>UV 185 nm Activation →</p> </div>
11	Press 3 times on  .	<div style="border: 1px solid black; padding: 5px;"> <p>STANDBY</p> <p>21 Aug 2008 21:58</p> <p>Menu →</p> <p>Ready →</p> </div>

Software

Overview

Introduction The purpose of this chapter is to explain the various software used in the System.

Contents This chapter contains the following topics:

Topic	See Page
Software Map	36
Standby Mode	37
Manager Menu	40
Ready Mode	43

Software Map

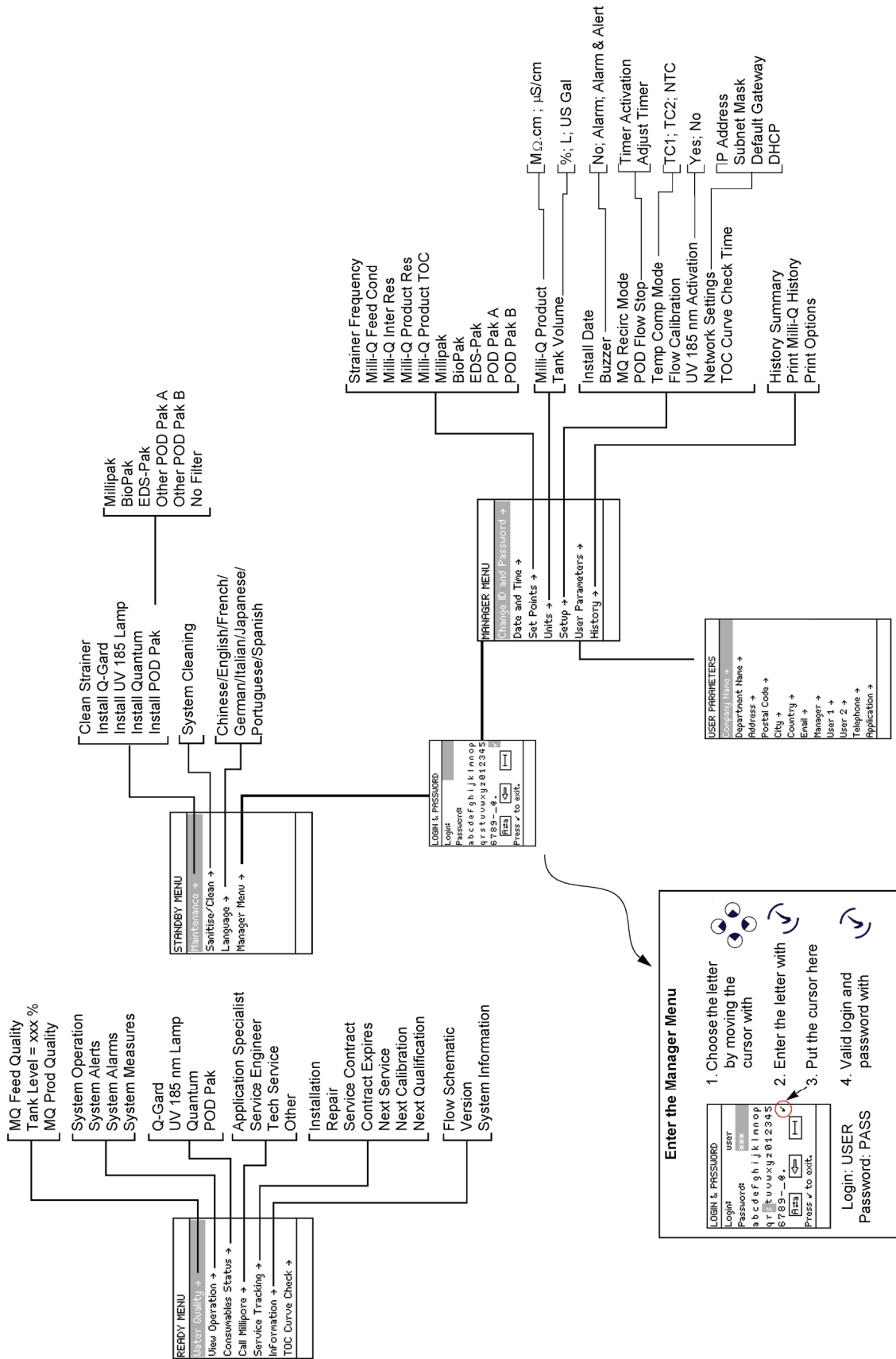

Standby Mode

General information

Purpose STANDBY mode is used primarily for:

- maintenance actions, and
- going to the Manager Menu.

Display

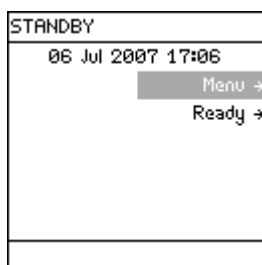



READY Mode from STANDBY Mode

Diagram 1	Action	Diagram 2
	<p>Press .</p>	



Description of Standby Menu

Maintenance The Maintenance Menu is described below.

Diagram 1	Diagram 2
	

Item	Description
Clean Strainer	Used to reset Alert message 'EXAMINE INLET STRAINER'.
Install Q-Gard	Used to see general information about the Q-Gard Pack exchange.
Install UV 185 Lamp	Used to reset Alert message 'REPLACE 185 NM LAMP'.
Install Quantum	Used to see general information about the Quantum Cartridge exchange.
Install POD Pak	Used to reset Alert message 'REPLACE POD PAK'.

Sanitise/clean

Diagram 1	Diagram 2
	

Item	Description
System Cleaning	Contact Millipore for more information.

Continued on next page

Description of Standby Menu, Continued

Language

Diagram 1	Diagram 2																
<table border="1"> <tr><td>STANDBY MENU</td></tr> <tr><td>Maintenance →</td></tr> <tr><td>Sanitise/Clean →</td></tr> <tr style="background-color: #cccccc;"><td>Language →</td></tr> <tr><td>Manager Menu →</td></tr> <tr><td> </td></tr> <tr><td> </td></tr> </table>	STANDBY MENU	Maintenance →	Sanitise/Clean →	Language →	Manager Menu →			<table border="1"> <tr><td>LANGUAGE</td></tr> <tr><td>Chinese</td></tr> <tr style="background-color: #cccccc;"><td>English ✓</td></tr> <tr><td>French</td></tr> <tr><td>German</td></tr> <tr><td>Italian</td></tr> <tr><td>Japanese</td></tr> <tr><td>Portuguese</td></tr> <tr><td> </td></tr> </table>	LANGUAGE	Chinese	English ✓	French	German	Italian	Japanese	Portuguese	
STANDBY MENU																	
Maintenance →																	
Sanitise/Clean →																	
Language →																	
Manager Menu →																	
LANGUAGE																	
Chinese																	
English ✓																	
French																	
German																	
Italian																	
Japanese																	
Portuguese																	



Item	Description
Language	Change the displayed language.

Manager Menu

Description

How to enter See the [Software Map](#) at the beginning of this chapter. The map shows how to enter the Manager Menu.
To enter the Manager Menu, it is necessary to input a Login and a Password. The Software Map indicates how to input a Login and a Password.

Change ID and Password

Diagram 1	Diagram 2
	

Item	Description
CHANGE ID & PASSWORD	Change the Login and Password used to enter the Manager Menu.

Date and Time

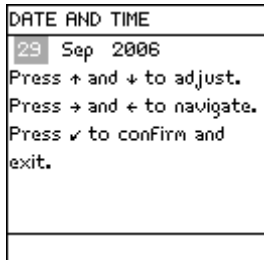
Diagram 1	Diagram 2
	

Item	Description
DATE AND TIME	Adjust your local date and time.

Continued on next page

Description, Continued

Set Points

Diagram 1	Diagram 2																												
<table border="1" style="width: 100%;"> <tr><td>MANAGER MENU</td></tr> <tr><td>Change ID and Password →</td></tr> <tr><td>Date and Time →</td></tr> <tr style="background-color: #e0e0e0;"><td>Set Points →</td></tr> <tr><td>Units →</td></tr> <tr><td>Setup →</td></tr> <tr><td>User Parameters →</td></tr> <tr><td>History →</td></tr> <tr><td> </td></tr> </table>	MANAGER MENU	Change ID and Password →	Date and Time →	Set Points →	Units →	Setup →	User Parameters →	History →		<table border="1" style="width: 100%;"> <tr><td>SET POINTS</td></tr> <tr style="background-color: #e0e0e0;"><td>Strainer Frequency →</td></tr> <tr><td>Milli-Q Feed Cond →</td></tr> <tr><td>Milli-Q Inter Res →</td></tr> <tr><td>Milli-Q Product Res →</td></tr> <tr><td>Milli-Q Product TOC →</td></tr> <tr><td>Millipak →</td></tr> <tr><td>BioPak →</td></tr> <tr><td> </td></tr> </table>	SET POINTS	Strainer Frequency →	Milli-Q Feed Cond →	Milli-Q Inter Res →	Milli-Q Product Res →	Milli-Q Product TOC →	Millipak →	BioPak →		<table border="1" style="width: 100%;"> <tr><td>SET POINTS</td></tr> <tr><td>Milli-Q Product Res →</td></tr> <tr><td>Milli-Q Product TOC →</td></tr> <tr><td>Millipak →</td></tr> <tr><td>BioPak →</td></tr> <tr><td>EDS-Pak →</td></tr> <tr><td>Pod Pak A →</td></tr> <tr style="background-color: #e0e0e0;"><td>Pod Pak B →</td></tr> <tr><td> </td></tr> </table>	SET POINTS	Milli-Q Product Res →	Milli-Q Product TOC →	Millipak →	BioPak →	EDS-Pak →	Pod Pak A →	Pod Pak B →	
MANAGER MENU																													
Change ID and Password →																													
Date and Time →																													
Set Points →																													
Units →																													
Setup →																													
User Parameters →																													
History →																													
SET POINTS																													
Strainer Frequency →																													
Milli-Q Feed Cond →																													
Milli-Q Inter Res →																													
Milli-Q Product Res →																													
Milli-Q Product TOC →																													
Millipak →																													
BioPak →																													
SET POINTS																													
Milli-Q Product Res →																													
Milli-Q Product TOC →																													
Millipak →																													
BioPak →																													
EDS-Pak →																													
Pod Pak A →																													
Pod Pak B →																													

Item	Description
Strainer Frequency	Change set points for controlling the frequency of the message EXAMINE INLET STRAINER.
Milli-Q Feed Cond	Change set point controlling the message MILLI-Q FEED CONDUCTIVITY > SP.
Milli-Q Inter Res	Change set point controlling the message MILLI-Q INTER R < SP, PLEASE ORDER Q-GARD AND QUANTUM.
Milli-Q Product Res	Change set point controlling the message MILLI-Q RES < SP, REPLACE Q-GARD AND QUANTUM.
Milli-Q Product TOC	Change set point controlling the message MILLI-Q TOC > SP.
Millipak	Change set point controlling the message REPLACE POD PAK IN XX DAYS (where $1 \leq XX \leq 15$).
BioPak, EDS-Pak, POD Pak	See above.

Units

Diagram 1	Diagram 2													
<table border="1" style="width: 100%;"> <tr><td>MANAGER MENU</td></tr> <tr><td>Change ID and Password →</td></tr> <tr><td>Date and Time →</td></tr> <tr><td>Set Points →</td></tr> <tr style="background-color: #e0e0e0;"><td>Units →</td></tr> <tr><td>Setup →</td></tr> <tr><td>User Parameters →</td></tr> <tr><td>History →</td></tr> <tr><td> </td></tr> </table>	MANAGER MENU	Change ID and Password →	Date and Time →	Set Points →	Units →	Setup →	User Parameters →	History →		<table border="1" style="width: 100%;"> <tr><td>UNITS</td></tr> <tr style="background-color: #e0e0e0;"><td>Milli-Q Product →</td></tr> <tr><td>Tank Volume →</td></tr> <tr><td> </td></tr> </table>	UNITS	Milli-Q Product →	Tank Volume →	
MANAGER MENU														
Change ID and Password →														
Date and Time →														
Set Points →														
Units →														
Setup →														
User Parameters →														
History →														
UNITS														
Milli-Q Product →														
Tank Volume →														

Item	Description
Milli-Q Product	<ul style="list-style-type: none"> • Change the displayed units of Milli-Q Product Water quality. • Choices are MΩ.cm or μS/cm.
Tank Volume	<ul style="list-style-type: none"> • Change the displayed units of Tank Volume. • Choices are % full, Litres or US Gallons.

Continued on next page

Description, Continued

Setup

Diagram 1	Diagram 2																										
<table border="1"> <tr><td>MANAGER MENU</td></tr> <tr><td>Change ID and Password →</td></tr> <tr><td>Date and Time →</td></tr> <tr><td>Set Points →</td></tr> <tr><td>Units →</td></tr> <tr><td>Setup →</td></tr> <tr><td>User Parameters →</td></tr> <tr><td>History →</td></tr> <tr><td> </td></tr> </table>	MANAGER MENU	Change ID and Password →	Date and Time →	Set Points →	Units →	Setup →	User Parameters →	History →		<table border="1"> <tr><td>SETUP</td></tr> <tr><td>Install Date →</td></tr> <tr><td>Buzzer →</td></tr> <tr><td>MQ Recirc Mode →</td></tr> <tr><td>POD Flow Stop →</td></tr> <tr><td>Temp Comp Mode →</td></tr> <tr><td>Flow Calibration →</td></tr> <tr><td>UV 185 nm Activation →</td></tr> <tr><td> </td></tr> </table>	SETUP	Install Date →	Buzzer →	MQ Recirc Mode →	POD Flow Stop →	Temp Comp Mode →	Flow Calibration →	UV 185 nm Activation →		<table border="1"> <tr><td>SETUP</td></tr> <tr><td>POD Flow Stop →</td></tr> <tr><td>Temp Comp Mode →</td></tr> <tr><td>Flow Calibration →</td></tr> <tr><td>UV 185 nm Activation →</td></tr> <tr><td>Network Settings →</td></tr> <tr><td> </td></tr> </table>	SETUP	POD Flow Stop →	Temp Comp Mode →	Flow Calibration →	UV 185 nm Activation →	Network Settings →	
MANAGER MENU																											
Change ID and Password →																											
Date and Time →																											
Set Points →																											
Units →																											
Setup →																											
User Parameters →																											
History →																											
SETUP																											
Install Date →																											
Buzzer →																											
MQ Recirc Mode →																											
POD Flow Stop →																											
Temp Comp Mode →																											
Flow Calibration →																											
UV 185 nm Activation →																											
SETUP																											
POD Flow Stop →																											
Temp Comp Mode →																											
Flow Calibration →																											
UV 185 nm Activation →																											
Network Settings →																											

Item	Description
Install Date	Change the installation date.
Buzzer	Change the trigger for the Buzzer.
MQ Recirc Mode	Change the amount of time that the System automatically recirculates every hour in READY Mode.
POD Flow Stop	Change the amount of time that the POD Unit dispenses continuously before it automatically stops.
Temp Comp	Change the Temperature Compensation Mode.
Flow Calibration	Used for performing a flow calibration.
UV 185 nm Activation	Used to activate or deactivate the UV 185 nm Lamp.
Network Settings	<ul style="list-style-type: none"> • Change Network settings. • Contact Millipore for more information.

Ready Mode

General information

Purpose In READY Mode, water can be dispensed from the POD Unit. The System should be left in READY Mode most of the time.

Display

READY
21 Aug 2008 23:13
Menu →
Standby →
Volume →
Recirculation →
Res: 18.2 MΩcm TC
T: 24.9 °C TOC: _ _ ppb

STANDBY Mode from READY Mode

Display	Action	Result												
<table border="1"> <tr><td>READY</td></tr> <tr><td>15 Dec 2008 21:35</td></tr> <tr><td>Menu →</td></tr> <tr><td>Standby →</td></tr> <tr><td>Volume →</td></tr> <tr><td>Recirculation →</td></tr> <tr><td>Res: 18.2 MΩcm TC</td></tr> <tr><td>T: 24.9 °C TOC: _ _ ppb</td></tr> </table>	READY	15 Dec 2008 21:35	Menu →	Standby →	Volume →	Recirculation →	Res: 18.2 MΩcm TC	T: 24.9 °C TOC: _ _ ppb	Press 	<table border="1"> <tr><td>STANDBY</td></tr> <tr><td>15 Dec 2008 21:36</td></tr> <tr><td>Menu →</td></tr> <tr><td>Ready →</td></tr> </table>	STANDBY	15 Dec 2008 21:36	Menu →	Ready →
READY														
15 Dec 2008 21:35														
Menu →														
Standby →														
Volume →														
Recirculation →														
Res: 18.2 MΩcm TC														
T: 24.9 °C TOC: _ _ ppb														
STANDBY														
15 Dec 2008 21:36														
Menu →														
Ready →														

READY Mode – water quality values

The READY Mode screen display is explained below.

READY Mode screen	Explanation								
<table border="1"> <tr><td>READY</td></tr> <tr><td>21 Aug 2008 23:13</td></tr> <tr><td>Menu →</td></tr> <tr><td>Standby →</td></tr> <tr><td>Volume →</td></tr> <tr><td>Recirculation →</td></tr> <tr><td>Res: 18.2 MΩcm TC</td></tr> <tr><td>T: 24.9 °C TOC: _ _ ppb</td></tr> </table>	READY	21 Aug 2008 23:13	Menu →	Standby →	Volume →	Recirculation →	Res: 18.2 MΩcm TC	T: 24.9 °C TOC: _ _ ppb	<p>In this example, the water being dispensed has:</p> <ul style="list-style-type: none"> • a resistivity of 18.2 MΩ.cm temperature compensated (TC) to 25°C, • a temperature of 24.9°C, and • the TOC is not measured.
READY									
21 Aug 2008 23:13									
Menu →									
Standby →									
Volume →									
Recirculation →									
Res: 18.2 MΩcm TC									
T: 24.9 °C TOC: _ _ ppb									
<table border="1"> <tr><td>READY</td></tr> <tr><td>22 Aug 2008 20:09</td></tr> <tr><td>Menu →</td></tr> <tr><td>Standby →</td></tr> <tr><td>Volume →</td></tr> <tr><td>Recirculation →</td></tr> <tr><td>Res: _ _ MΩcm TC</td></tr> <tr><td>T: _ _ °C TOC: _ _ ppb</td></tr> </table>	READY	22 Aug 2008 20:09	Menu →	Standby →	Volume →	Recirculation →	Res: _ _ MΩcm TC	T: _ _ °C TOC: _ _ ppb	<p>In this example, the System is powered on but is not dispensing or recirculating water. As a result, there are no water quality measurements to display.</p> <p>NOTE: A Milli-Q Reference System can be upgraded to have TOC measurements. Contact Millipore for more information.</p>
READY									
22 Aug 2008 20:09									
Menu →									
Standby →									
Volume →									
Recirculation →									
Res: _ _ MΩcm TC									
T: _ _ °C TOC: _ _ ppb									

Description of Ready Menu

Water Quality

Diagram 1	Diagram 2														
<table border="1"> <tr><td>READY MENU</td></tr> <tr><td>Water Quality →</td></tr> <tr><td>View Operation →</td></tr> <tr><td>Consumables Status →</td></tr> <tr><td>Call Millipore →</td></tr> <tr><td>Service Tracking →</td></tr> <tr><td>Information →</td></tr> <tr><td>TOC Curve Check →</td></tr> <tr><td> </td></tr> </table>	READY MENU	Water Quality →	View Operation →	Consumables Status →	Call Millipore →	Service Tracking →	Information →	TOC Curve Check →		<table border="1"> <tr><td>WATER QUALITY</td></tr> <tr><td>MQ Feed Quality →</td></tr> <tr><td>Tank Level : 88.8 %</td></tr> <tr><td>MQ Prod Quality →</td></tr> <tr><td> </td></tr> </table>	WATER QUALITY	MQ Feed Quality →	Tank Level : 88.8 %	MQ Prod Quality →	
READY MENU															
Water Quality →															
View Operation →															
Consumables Status →															
Call Millipore →															
Service Tracking →															
Information →															
TOC Curve Check →															
WATER QUALITY															
MQ Feed Quality →															
Tank Level : 88.8 %															
MQ Prod Quality →															

Item	Description
MQ Feed Quality	View the feedwater quality (accessory)
Tank Level	View the level of water in the Reservoir.
MQ Prod Quality	View the quality of water obtained from the POD Unit.

View Operation

Diagram 1	Diagram 2															
<table border="1"> <tr><td>READY MENU</td></tr> <tr><td>Water Quality →</td></tr> <tr><td>View Operation →</td></tr> <tr><td>Consumables Status →</td></tr> <tr><td>Call Millipore →</td></tr> <tr><td>Service Tracking →</td></tr> <tr><td>Information →</td></tr> <tr><td>TOC Curve Check →</td></tr> <tr><td> </td></tr> </table>	READY MENU	Water Quality →	View Operation →	Consumables Status →	Call Millipore →	Service Tracking →	Information →	TOC Curve Check →		<table border="1"> <tr><td>VIEW OPERATION</td></tr> <tr><td>System Operation →</td></tr> <tr><td>System Alerts →</td></tr> <tr><td>System Alarms →</td></tr> <tr><td>System Measures →</td></tr> <tr><td> </td></tr> </table>	VIEW OPERATION	System Operation →	System Alerts →	System Alarms →	System Measures →	
READY MENU																
Water Quality →																
View Operation →																
Consumables Status →																
Call Millipore →																
Service Tracking →																
Information →																
TOC Curve Check →																
VIEW OPERATION																
System Operation →																
System Alerts →																
System Alarms →																
System Measures →																

Item	Description
System Operation	View operating parameters: <ul style="list-style-type: none"> • operating mode, • status of pump, and • status of UV Lamp.
System Alerts	View a list of active Alert messages. See the Alert Chapter for more information.
System Alarms	View a list of active Alarm messages. See the Alarm Chapter for more information.
System Measures	View: <ul style="list-style-type: none"> • accumulated production time, • pump electrical data, • UV Lamp electrical data, and • Intermediate Resistivity and temperature measurements.

Continued on next page

Description of Ready Menu, Continued

Consumables Status

Diagram 1	Diagram 2													
<table border="1"> <tr><td>READY MENU</td></tr> <tr><td>Water Quality →</td></tr> <tr><td>View Operation →</td></tr> <tr><td>Consumables Status →</td></tr> <tr><td>Call Millipore →</td></tr> <tr><td>Service Tracking →</td></tr> <tr><td>Information →</td></tr> <tr><td>TOC Curve Check →</td></tr> </table>	READY MENU	Water Quality →	View Operation →	Consumables Status →	Call Millipore →	Service Tracking →	Information →	TOC Curve Check →	<table border="1"> <tr><td>CONSUMABLES STATUS</td></tr> <tr><td>Q-Gard →</td></tr> <tr><td>UV 185 nm Lamp →</td></tr> <tr><td>Quantum →</td></tr> <tr><td>POD Pak →</td></tr> </table>	CONSUMABLES STATUS	Q-Gard →	UV 185 nm Lamp →	Quantum →	POD Pak →
READY MENU														
Water Quality →														
View Operation →														
Consumables Status →														
Call Millipore →														
Service Tracking →														
Information →														
TOC Curve Check →														
CONSUMABLES STATUS														
Q-Gard →														
UV 185 nm Lamp →														
Quantum →														
POD Pak →														

Consumable	Description
Q-Gard	View information about various consumable items. Information may include: <ul style="list-style-type: none"> • installation date, • lifetime remaining, • volume processed, • catalogue number, and • serial number <p>NOTE: The five items listed above may not be shown in each Consumable Status screen.</p>
UV 185 nm Lamp	
Quantum	
POD Pak	

Call Millipore

Diagram 1	Diagram 2													
<table border="1"> <tr><td>READY MENU</td></tr> <tr><td>Water Quality →</td></tr> <tr><td>View Operation →</td></tr> <tr><td>Consumables Status →</td></tr> <tr><td>Call Millipore →</td></tr> <tr><td>Service Tracking →</td></tr> <tr><td>Information →</td></tr> <tr><td>TOC Curve Check →</td></tr> </table>	READY MENU	Water Quality →	View Operation →	Consumables Status →	Call Millipore →	Service Tracking →	Information →	TOC Curve Check →	<table border="1"> <tr><td>CALL MILLIPORE</td></tr> <tr><td>Application Specialist →</td></tr> <tr><td>Service Engineer →</td></tr> <tr><td>Tech Service →</td></tr> <tr><td>Other →</td></tr> </table>	CALL MILLIPORE	Application Specialist →	Service Engineer →	Tech Service →	Other →
READY MENU														
Water Quality →														
View Operation →														
Consumables Status →														
Call Millipore →														
Service Tracking →														
Information →														
TOC Curve Check →														
CALL MILLIPORE														
Application Specialist →														
Service Engineer →														
Tech Service →														
Other →														

Item	Description
Application Specialist	View: <ul style="list-style-type: none"> • name, • phone number, and • email address of a Millipore Representative. <p>NOTE: This information is entered by a Millipore Service Representative.</p>
Service Engineer	
Tech Service	
Other	

Continued on next page

Description of Ready Menu, Continued

Service Tracking

Diagram 1	Diagram 2																
<table border="1"> <tr><td>READY MENU</td></tr> <tr><td>Water Quality →</td></tr> <tr><td>View Operation →</td></tr> <tr><td>Consumables Status →</td></tr> <tr><td>Call Millipore →</td></tr> <tr><td>Service Tracking →</td></tr> <tr><td>Information →</td></tr> <tr><td>TOC Curve Check →</td></tr> </table>	READY MENU	Water Quality →	View Operation →	Consumables Status →	Call Millipore →	Service Tracking →	Information →	TOC Curve Check →	<table border="1"> <tr><td>SERVICE TRACKING</td></tr> <tr><td>Installation →</td></tr> <tr><td>Repair →</td></tr> <tr><td>Service Contract →</td></tr> <tr><td>Contract Expires →</td></tr> <tr><td>Next Service →</td></tr> <tr><td>Next Calibration →</td></tr> <tr><td>Next Qualification →</td></tr> </table>	SERVICE TRACKING	Installation →	Repair →	Service Contract →	Contract Expires →	Next Service →	Next Calibration →	Next Qualification →
READY MENU																	
Water Quality →																	
View Operation →																	
Consumables Status →																	
Call Millipore →																	
Service Tracking →																	
Information →																	
TOC Curve Check →																	
SERVICE TRACKING																	
Installation →																	
Repair →																	
Service Contract →																	
Contract Expires →																	
Next Service →																	
Next Calibration →																	
Next Qualification →																	

Item	Description
Installation	View information that was inputted into the System at time of servicing.
Repair	
Service Contract	View information related to upcoming service.
Contract Expires	
Next Service	NOTE: This information is entered by a Millipore Representative.
Next Calibration	
Next Qualification	

Information

Diagram 1	Diagram 2												
<table border="1"> <tr><td>READY MENU</td></tr> <tr><td>Water Quality →</td></tr> <tr><td>View Operation →</td></tr> <tr><td>Consumables Status →</td></tr> <tr><td>Call Millipore →</td></tr> <tr><td>Service Tracking →</td></tr> <tr><td>Information →</td></tr> <tr><td>TOC Curve Check →</td></tr> </table>	READY MENU	Water Quality →	View Operation →	Consumables Status →	Call Millipore →	Service Tracking →	Information →	TOC Curve Check →	<table border="1"> <tr><td>INFORMATION</td></tr> <tr><td>Flow Schematic →</td></tr> <tr><td>Version →</td></tr> <tr><td>System Information →</td></tr> </table>	INFORMATION	Flow Schematic →	Version →	System Information →
READY MENU													
Water Quality →													
View Operation →													
Consumables Status →													
Call Millipore →													
Service Tracking →													
Information →													
TOC Curve Check →													
INFORMATION													
Flow Schematic →													
Version →													
System Information →													

Item	Description
Flow Schematic	View information that explains the purpose of the major components.
Version	View Software versions.
System Information	View: <ul style="list-style-type: none"> • System Type, • Catalogue Number, • Serial Number, • Installation Date, and • Manufacturing Date.

Using the Milli-Q System

Overview

Introduction

The purpose of this chapter is to explain:

- various ways that water can be dispensed from the System, and
 - how to view information, operating parameters and other things about the System.
-





Contents

This chapter contains the following topics:

Topic	See Page
Dispensing water	48
Viewing water quality	51
Viewing Operation	52
Viewing Consumable Status	54
Calling Millipore	55
Viewing Information	56

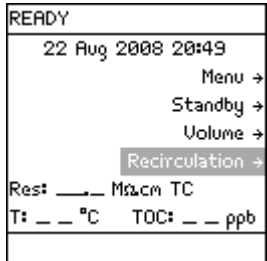
Dispensing water

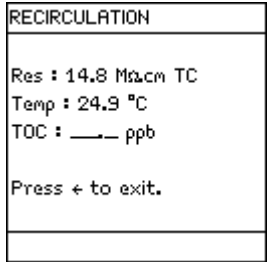
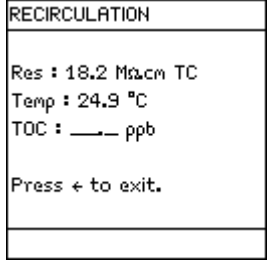
Optimise Water Quality Product Water can be recirculated within the System before dispensing it. This helps optimised water quality. Follow the steps below to do this.

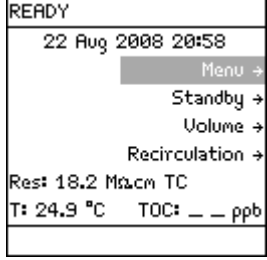
Step	Action	Diagram
1	Start in READY Mode. <i>NOTE:</i> The Resistivity and temperature values may or may not be shown at this time.	 <pre> READY 22 Aug 2008 20:49 Menu → Standby → Volume → Recirculation → Res: ___ MΩcm TC T: ___ °C TOC: ___ ppb </pre>
2	<ul style="list-style-type: none"> • Select Recirculation. • Press . 	 <pre> RECIRCULATION Res : 14.8 MΩcm TC Temp : 24.9 °C TOC : ___ ppb Press ← to exit. </pre>
3	Wait until the Product water quality is optimised.	 <pre> RECIRCULATION Res : 18.2 MΩcm TC Temp : 24.9 °C TOC : ___ ppb Press ← to exit. </pre>
4	Press  .	 <pre> READY 22 Aug 2008 20:58 Menu → Standby → Volume → Recirculation → Res: 18.2 MΩcm TC T: 24.9 °C TOC: ___ ppb </pre>

Continued on next page

Dispensing water, Continued

Using the POD Plunger

To dispense water, press down on the POD Unit plunger while in READY Mode.

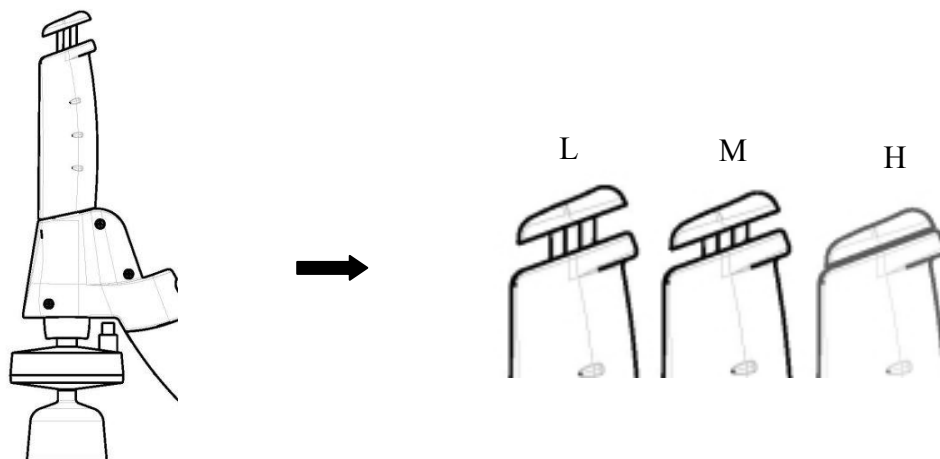

Position	Water flow
L	Low Flow (push slightly)
M	Medium Flow (push slightly)
H	High Flow (push down and hold, release when done)
H	Continuous high flow (push down and release; push down again to stop).

Volumetric dispensing

Follow the steps below to volumetrically dispense from the POD Unit.

Step	Action	Diagram
1	Make sure the System is in READY Mode.	<p>READY 15 Dec 2008 22:06 Menu → Standby → Volume → Recirculation → Res: 18.2 MΩcm TC T: 24.9 °C TOC: — ppb</p>
2	Select Volume. Press	<p>VOLUME SETUP Volume : 1.00 L Press ↑ and ↓ to adjust. Press ✓ to deliver water. Press ← to exit.</p>

Continued on next page

Dispensing water, Continued



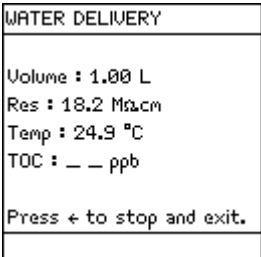
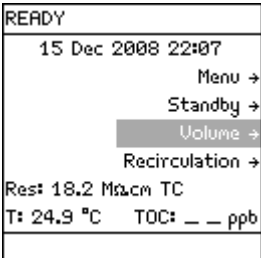
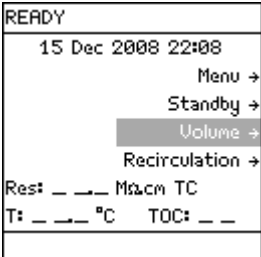

Volumetric dispensing (continued)

Step	Action	Diagram
3	Select the desired volume of water to be delivered. Press  .	
4	When the volumetric dispensing is finished, the System recirculates water for 3 minutes.	
5	The System stops recirculating water.	

Viewing water quality

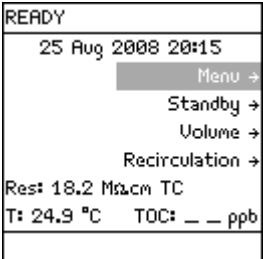
Procedure

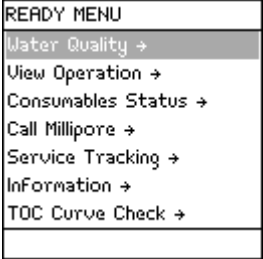
Follow the steps below to view the water quality.

Step	Action	Diagram
1	Make sure the System is in READY Mode. <i>NOTE:</i> The Resistivity (Res) and Temperature (T) are seen in the main READY Mode screen.	
2	To see Tank Level indicator, select Menu. Press  .	
3	Select Water Quality. Press  . The Tank Level is shown if the System is configured to have a level sensor.	

Viewing Operation



Introduction

VIEW OPERATION allows you to see the status of major components. Under the View Operation LCD, the following items can be selected:

- System Operation,
- System Alerts,
- System Alarms, and
- System Measures

System Operation

Follow the steps below to go to the System Operation LCD.

Step	Action	Diagram
1	Start in READY Mode.	
2	Select Menu. Press  .	
3	Select View Operation. Press  .	
4	Select System Operation. Press  .	

Continued on next page

Viewing Operation, Continued

System Alerts

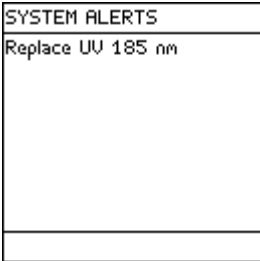
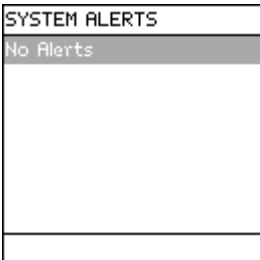
<p>An example Alert is shown here. This is an Alert that is currently being displayed on the bottom of the Main Display in READY Mode or in STANDBY Mode.</p>	
<p>When the timer for the UV 185 nm Lamp is reset, then this Alert is no longer shown on the SYSTEM ALERTS LCD.</p>	

System Alarms

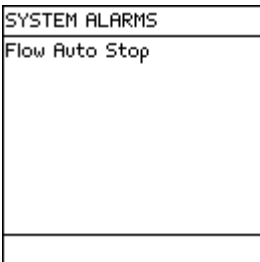
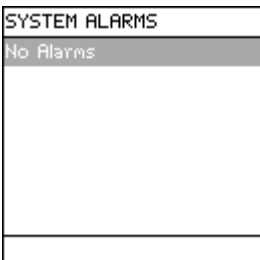
<p>An example Alarm is shown here. This is an Alarm that is currently displayed on the Main Display unless you override the display for one hour.</p>	
<p>When the cause of this Alarm is fixed, then this Alarm is no longer shown on the SYSTEM ALARMS LCD.</p>	



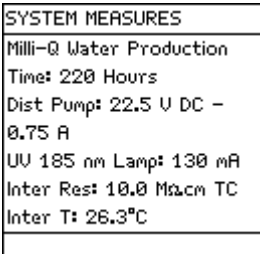



System Measures

<p>Various measurements related to the System are shown here.</p>	
---	---

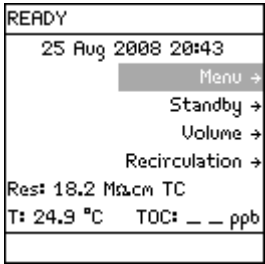
Viewing Consumable Status

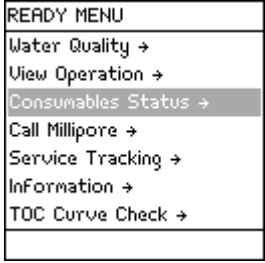
Introduction Consumables Status allows you to see information related to the various consumables.

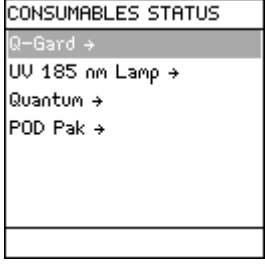
Procedure Follow the steps below to view Consumables Status.

Step	Action	Diagram
1	Start in READY Mode.	
2	Select Menu. Press  .	
3	Select Consumables Status. Press  .	
4	Select the consumable that you would like to see information about. As an example, the Quantum Cartridge status is shown here. Choose other consumables to see their status.	







Calling Millipore

Introduction

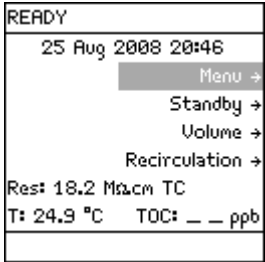
Call Millipore allows you to see contact information.
A Millipore Service Representative can enter this information into the System.

Procedure

Follow the steps below to view information under Call Millipore.

Step	Action	Diagram
1	Start in READY Mode.	
2	Select Menu. Press  .	
3	Select Call Millipore. Press  .	
4	Select the type of Millipore Representative you wish to contact. Press  .	

Viewing Information







Introduction

INFORMATION allows you to view:

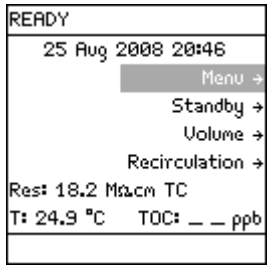
- flow schematic information,
- version information, and
- serial number and other information.

Procedure

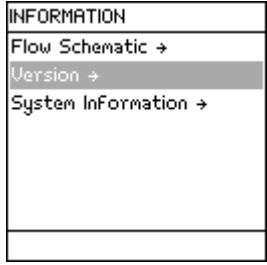
Follow the steps below to see information about the System.

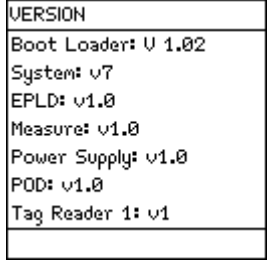
Step	Action	Diagram
1	Start in READY Mode.	
2	Select Menu. Press  .	
3	Select Information. Press  .	
4	Select the type of information you wish to view. Two examples are shown below. Press  .	

Continued on next page

Viewing Information, Continued

Version

The various versions for the System are shown here.

<p>This LCD shows the version used for various components inside the System.</p>	<table border="1"> <tr> <td>VERSION</td> </tr> <tr> <td>Boot Loader: V 1.02</td> </tr> <tr> <td>System: v7</td> </tr> <tr> <td>EPLD: v1.0</td> </tr> <tr> <td>Measure: v1.0</td> </tr> <tr> <td>Power Supply: v1.0</td> </tr> <tr> <td>Q-POD 1: v1.0</td> </tr> <tr> <td>Q-POD 2: v1.0</td> </tr> <tr> <td> </td> </tr> </table>	VERSION	Boot Loader: V 1.02	System: v7	EPLD: v1.0	Measure: v1.0	Power Supply: v1.0	Q-POD 1: v1.0	Q-POD 2: v1.0	
VERSION										
Boot Loader: V 1.02										
System: v7										
EPLD: v1.0										
Measure: v1.0										
Power Supply: v1.0										
Q-POD 1: v1.0										
Q-POD 2: v1.0										

System Information

The Catalogue Number, Serial Number and other information are shown here. The Serial Number is something you should reference when you contact Millipore.

<p>This LCD shows information such as the Serial Number and the Catalogue Number.</p> <p>NOTE: The Inst Date (Installation Date) needs to be entered by a Millipore Service Representative. The date is not automatically generated by the System.</p>	<table border="1"> <tr> <td>SYSTEM INFORMATION</td> </tr> <tr> <td>Milli-Q Reference</td> </tr> <tr> <td>Cat N°: ZRX0003T0</td> </tr> <tr> <td>Serial N°: F6DN27327B</td> </tr> <tr> <td>MFG Date: 1 April 2006</td> </tr> <tr> <td>Inst Date: 1 June 2006 ←</td> </tr> <tr> <td> </td> </tr> </table>	SYSTEM INFORMATION	Milli-Q Reference	Cat N°: ZRX0003T0	Serial N°: F6DN27327B	MFG Date: 1 April 2006	Inst Date: 1 June 2006 ←	
SYSTEM INFORMATION								
Milli-Q Reference								
Cat N°: ZRX0003T0								
Serial N°: F6DN27327B								
MFG Date: 1 April 2006								
Inst Date: 1 June 2006 ←								

Maintenance

Overview

Introduction The purpose of this chapter is to explain the common maintenance needed for a System.

Contents This chapter contains the following topics:

Topic	See Page
Maintenance Schedule	59
Replacing the Q-Gard Pack	60
Replacing the Quantum Cartridge	63
Replacing a POD Pak	67
Cleaning the Inlet Strainer	70
Calibrating the Flowrate	73

Maintenance Schedule

Consumables

Item	Maintenance needed	When
Q-Gard Pack	Replacement	Prompted to by an LCD message.
Quantum Cartridge	Replacement	Prompted to by an LCD message.
POD Pak	Replacement	Prompted to by an LCD message or as necessary.

Lamp

Item	Maintenance needed	When
UV 185 nm Lamp	Replacement	Prompted to by an LCD message.

NOTE:

It is recommended to have a Millipore Field Service Representative change the UV Lamp in the system.

The replacement of this lamp involves removing the cover of the system. The instructions for replacing these lamps are not included in this User Manual. The instructions are included with the replacement lamp.

Cleaning/ Sanitisation

Item	Maintenance needed	When
Inlet Strainer	Cleaning	Prompted to by an LCD message or as necessary.
System	Sanitisation	Contact Millipore for more details.

Calibrating the flowrate



Item	Maintenance needed	When
Flowmeter	Recalibration	New Consumable, Sensor or change to Feedwater. See 'Calibrating the Flowrate' for more information.

Replacing the Q-Gard Pack

When The Q-Gard Pack should be replaced when one of the following Alarm or Alert messages is displayed.

- Alarm message = MILLI-Q RES < SP, REPLACE Q-GARD AND QUANTUM
- Alert message = REPLACE Q-GARD PACK



Removing Remove the used Q-Gard Pack by following the steps below.

Step	Action	Diagram
1	Place the system into STANDBY Mode.	
2	Push the POD Plunger down once to depressurise the System. After water stops being dispensed, push down the POD Plunger again.	
3	Open the System left door. Lift up the Pack Locking Handle.	

Continued on next page

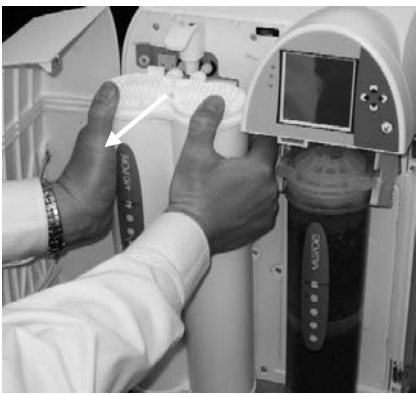

Replacing the Q-Gard Pack, Continued

Removing (continued)

Step	Action	Diagram
4	Remove the used Q-Gard Pack.	
5	The System will indicate that the Q-Gard Pack is removed in a few moments.	

Placing

Follow the steps below to install a new Q-Gard Pack.

Step	Action	Diagram
1	Remove the covers on the 2 ports of the Q-Gard Pack. Look inside the ports. Make sure the rubber O-rings are firmly in place. Wet the O-rings with water.	
2	Push the top of the Q-Gard Pack into the ports on the System. Push on the bottom of the Q-Gard Pack.	

Continued on next page

Replacing the Q-Gard Pack, Continued

Placing
(continued)

Step	Action	Diagram
3	Push the Pack Locking Handle down. Close the left door.	

Quantum Cartridge

The Quantum Cartridge should be replaced whenever the Q-Gard Pack is replaced in order to ensure optimal water quality. Proceed to the next section for information about replacing the Quantum Cartridge.



Replacing the Quantum Cartridge

When The Quantum Cartridge should be replaced when one of the following Alert or Alarm messages is displayed.

- Alert message = REPLACE QUANTUM CARTRIDGE
- Alarm message = MILLI-Q RES < SP, REPLACE Q-GARD AND QUANTUM

The Quantum Cartridge should be replaced whenever the Q-Gard Pack is replaced.

Removing Follow the steps below to remove the used Quantum Cartridge.

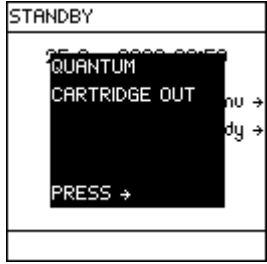



Step	Action	Diagram
1	Place the System into STANDBY Mode.	
2	Push the POD Plunger down once to depressurise the System. After water stops being dispensed, push down the POD Plunger again.	
3	Open the System right door. Remove the used Quantum Cartridge.	
4	In a few moments, the System indicates that the Quantum Cartridge is removed.	

Continued on next page

Replacing the Quantum Cartridge, Continued

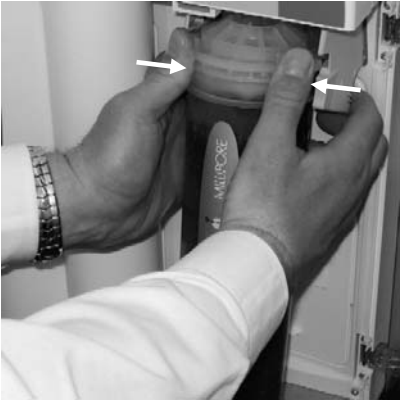
Placing

Follow the steps below to install a new Quantum Cartridge.

Step	Action	Diagram
1	Remove the covers on the 2 ports of the Quantum Cartridge. Wet the O-rings with water.	
2	Install the Quantum Cartridge until it is fully seated. Close the right door.	
3	When a new Quantum Cartridge is installed, the LCD looks like this.	
4	Press  .	

Proceed to the next set of steps to rinse the Quantum Cartridge.

Continued on next page

Replacing the Quantum Cartridge, Continued

Rinsing

The Quantum Cartridge, when newly installed, needs to be rinsed. This ensures optimal water quality.

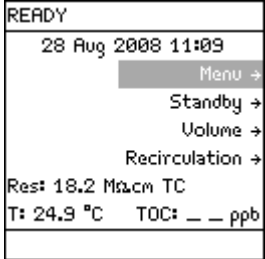
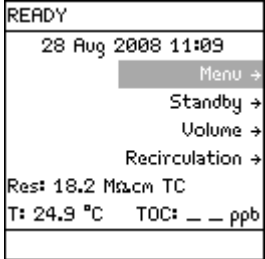
Step	Action	Diagram
1	<p>Locate the clear tubing and the barbed fitting from the System accessories bag. Screw the barbed fitting onto the POD Unit.</p> <p>NOTE: Do not use any white tape on the threads of the barbed fitting. An O-ring is located inside the POD Unit.</p> <p>Push one end of the clear tubing onto the end of the barbed fitting. Place the other end of the clear tubing into a sink.</p>	
2	<p>The System must be in READY Mode.</p>	
3	<p>Push the plunger down on the POD Unit. In a few minutes, water should dispense from the POD Unit.</p>	

Continued on next page

Replacing the Quantum Cartridge, Continued

Rinsing
(continued)

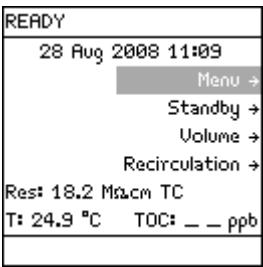
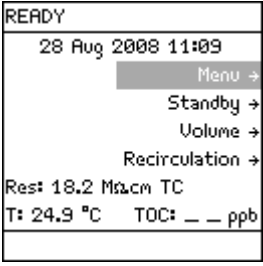
Step	Action	Diagram
4	<p>Dispense water for about 10 minutes.</p> <p>This flushes out any trapped air in most of the System.</p> <p>This also rinses off the purification media located in the Q-Gard Pack and the Quantum Cartridge.</p>	
5	<p>Leave the System in READY Mode when finished.</p>	

Replacing a POD Pak





Basing on flowrate One possible reason for a decrease in Milli-Q Water flowrate is a clogged POD Pak. The POD Pak should be replaced when it appears to be clogged. Make sure the POD Pak is not air-locked. Dispense water and open the vent to see if there is any trapped air. Close the vent after this.

Basing on LCD message The POD Pak needs replacement when the following Alert message is displayed.

- Alert message = REPLACE POD PAK

Placing and flushing Follow the instructions delivered with the POD Pak.









Registering The POD Pak installation has to be registered. Follow the steps below to register the installation of the POD Pak.

Step	Action	Diagram
1	Start in STANDBY Mode.	
2	Select Menu. Press  .	
3	Select Maintenance. Press  .	

Continued on next page

Replacing a POD Pak, Continued



Registering (continued)

Step	Action	Diagram
4	Scroll down to Install POD Pak.	 <p>MAINTENANCE Clean Strainer → Install Q-Gard → Install UV 185 Lamp → Install Quantum → Install POD Pak →</p>
5	Press  .	 <p>INSTALL POD PAK</p>
6	Press  .	 <p>INSTALL POD PAK Select the POD Pak that you wish to install. Press → to continue or ← to exit.</p>
7	In this example, the replacement POD Pak is a Millipak. Press  .	 <p>INSTALL POD PAK Millipak → BioPak → EDS-Pak → Other Pod Pak A → Other Pod Pak B → No Filter →</p>
8	Press  .	 <p>INSTALL POD PAK Follow the instructions delivered with the new POD Pak and press ✓. ←</p>

Continued on next page

Replacing a POD Pak, Continued

Registering
(continued)

Step	Action	Diagram
9	Press  .	<div style="border: 1px solid black; padding: 5px;"> <p>INSTALL POD PAK</p> <p>POD Pak installation is registered. Next maintenance in 182 days. Press ← to exit.</p> </div>
10	Press 3 times on  .	<div style="border: 1px solid black; padding: 5px;"> <p>STANDBY</p> <p>28 Aug 2008 11:32</p> <p style="text-align: right;">Menu →</p> <p style="text-align: right;">Ready →</p> </div>

Cleaning the Inlet Strainer

Purpose The purpose of the Inlet Strainer is to prevent a large particle from entering the System.
 If the Inlet Strainer becomes clogged, then feedwater does not flow freely to the System.
 Cleaning the Inlet Strainer removes any trapped debris.

When The Inlet Strainer should be cleaned when the following Alert message is displayed.
 • Alert message = EXAMINE INLET STRAINER
 The Inlet Strainer should also be cleaned whenever you suspect it is clogged.

Procedure Follow the steps below to clean the Inlet Strainer.

Step	Action
1	Go to STANDBY Mode.
2	Shut off the feedwater supply.
3	Unscrew the Inlet Strainer from the feedwater supply.
4	Detach the tubing on the other end of the Inlet Strainer.
5	Flush water backwards through the Inlet Strainer.
6	Apply 3 to 4 turns of new white tape to the threads of the feedwater pipe.
7	Screw the Inlet Strainer back onto the feedwater pipe.
8	Attach the tubing to the other end of the Inlet Strainer.
9	Open the feedwater supply valve.
10	Go to READY Mode.









Registering Follow the steps below to register the cleaning of the Inlet Strainer.

Step	Action	Diagram
1	Go to STANDBY Mode.	

Continued on next page

Cleaning the Inlet Strainer, Continued

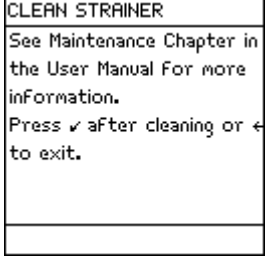

Registering (continued)

Step	Action	Diagram
2	Select Menu. Press  .	 <p>STANDBY MENU Maintenance → Sanitise/Clean → Language → Manager Menu →</p>
3	Select Maintenance. Press  .	 <p>MAINTENANCE Clean Strainer → Install Q-Gard → Install UV 185 Lamp → Install Quantum → Install POD Pak →</p>
4	Select Clean Strainer. Press  .	 <p>CLEAN STRAINER</p>
5	A picture is shown. Press  .	 <p>CLEAN STRAINER See Maintenance Chapter in the User Manual for more information. Press ✓ after cleaning or ← to exit.</p>
6	Press  .	 <p>CLEAN STRAINER The strainer cleaning date is registered. Next maintenance in 365 days. Press ← to exit.</p>

Continued on next page

Cleaning the Inlet Strainer, Continued

Registering
(continued)

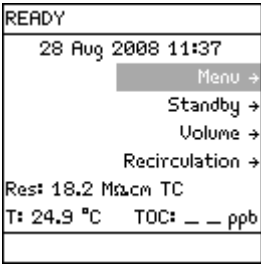
Step	Action	Diagram
7	Press 3 times on  .	 <p>STANDBY 28 Aug 2008 11:37 Menu → Ready →</p>
8	Go to READY Mode.	 <p>READY 28 Aug 2008 11:37 Menu → Standby → Volume → Recirculation → Res: 18.2 MΩcm TC T: 24.9 °C TOC: — — ppb</p>

Calibrating the Flowrate

- When** The flowrate should be calibrated when a:
- new consumable is installed such as a:
 - POD Pak, or
 - Q-Gard Pack, and
 - Quantum Cartridge
 - sensor or major component is changed.
 - feedwater parameter has changed such as the:
 - pressure
 - setting of pressure regulator,
 - larger or smaller Reservoir, or
 - Inlet Strainer cleaned
 - temperature changed ($> 3^{\circ}\text{C}$).
-

Procedure Follow the procedure shown in the Installation Chapter.

Alarms

Overview

Introduction The purpose of this chapter is to explain the Alarm messages shown on a System.

Specifically, this chapter explains how:

- an Alarm message is displayed,
- to read an Alarm message,
- to cancel an Alarm, and
- a list of Alarm messages is shown.

Contents This chapter contains the following topics:

Topic	See Page
Alarm Information	75
Summary of Alarm messages	79

Alarm Information

Definition An Alarm message is a way of informing you that immediate attention is required for the System.

Alarm shown – what to do?

It is not recommended to use the System when an Alarm message is shown. Contact Millipore if an Alarm message is shown and the problem can not be resolved.

Types The following table summarizes the different types of Alarm messages.

Type	Description
Alarm stops the System.	Some Alarms automatically stop the System from dispensing water. An example of this is the Alarm message QUANTUM CARTRIDGE OUT. The text display of this type of Alarm can be cancelled for one hour by using the Keypad.
Alarm does not stop the System.	Some Alarms do not automatically stop the System from dispensing water. An example of this is the Alarm message MILLI-Q T < MIN. The text display of this type of Alarm can be cancelled for one hour by using the Keypad.

Main Display The Alarm message is shown superimposed on the Main Display. The red LED is lit steadily when an Alarm message is shown. In this example, the Alarm Message MILLI-Q T > MAX is shown.



Continued on next page

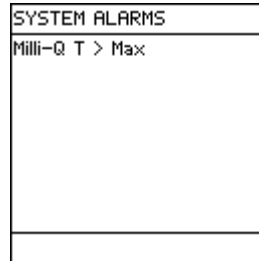

Alarm Information, Continued

System Alarms When an Alarm is shown, it is listed under the System Alarms LCD. See the section <View Operation> for information on how to access this LCD.



Viewing an Alarm Message

Follow the steps below to view an Alarm message.

Step	Action	Diagram
1	The Alarm message is shown superimposed on the Main Display.	<p>The diagram shows a rectangular LCD display. At the top, it says 'READY'. Below that, it displays '21 Aug 2008 19:57'. In the center, there is a black rectangular box with the text 'MILLI-Q T > MAX' in white. To the right of the box, there are four arrows pointing right, labeled 'nu →', 'by →', 'ne →', and 'on →'. At the bottom, it displays 'Res: PRESS →', 'T: 24.9 °C', and 'TOC: _ _ ppb'.</p>
2	Press  .	<p>See Alarms Chapter in the User Manual For more information. Press ✓ to cancel the display of this alarm For one hour or press ← to exit.</p>
3	Press  .	<p>The diagram is identical to the one in Step 1, showing the alarm message superimposed on the main display.</p>

Continued on next page

Alarm Information, Continued

Canceling an Alarm message

The display of an Alarm message can be cancelled by:

- fixing the cause of the Alarm, or
- using the Keypad. This cancels the display of the Alarm message for 1 hour.

Alarm – before cancelling

In this example, the Alarm message is MILLI-Q T > MAX.

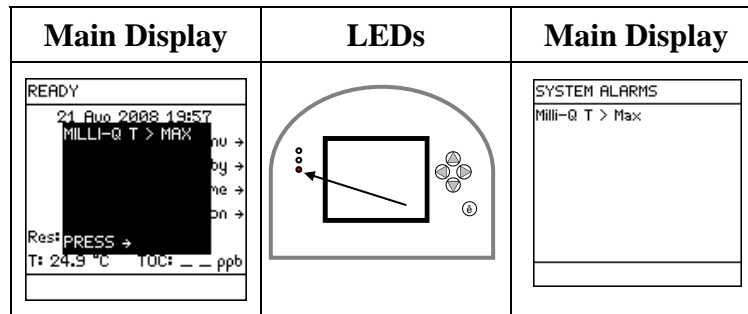

Canceling an Alarm message procedure

Follow the steps below to cancel an Alarm message.

Step	Action	Diagram
1	The Alarm message is shown superimposed on the Main Display.	<p>READY 21 Aug 2008 19:57 MILLI-Q T > MAX nu → by → me → on → Res: PRESS → T: 24.9 °C TOC: _ _ ppb</p>
2	Press .	<p>See Alarms Chapter in the User Manual For more information. Press ✓ to cancel the display of this alarm For one hour or press ← to exit.</p> <p>SYSTEM ALARMS MILLI-Q T > Max</p>
3	Press .	<p>The display of the Alarm is cancelled for one hour. It appears after one hour unless the cause of the Alarm is fixed.</p>

Continued on next page

Alarm Information, Continued

Alarm – after cancelling the text display

Main Display	LEDs	Main Display
<pre> READY 21 Aug 2008 20:01 Menu → Standby → Volume → Recirculation → Res: 18.2 MΩcm TC T: 24.9 °C TOC: _ _ ppb </pre>		<pre> SYSTEM ALARMS Milli-Q T > Max </pre>

Alarm – fixed

Now suppose a Millipore Service Representative fixes the cause of the Alarm.

Main Display	LEDs	Main Display
<pre> READY 21 Aug 2008 20:01 Menu → Standby → Volume → Recirculation → Res: 18.2 MΩcm TC T: 24.9 °C TOC: _ _ ppb </pre>		<pre> SYSTEM ALARMS No Alarms </pre>

Summary of Alarm messages

Alarm messages

LCD message	What it means
FLOW AUTO STOP	The System has automatically stopped dispensing water. The POD FLOW STOP timer has reached 0 minutes. Push the POD Unit Plunger all the way down and release. This resets the dispenser timer and makes the POD Unit available for dispensing.
INCORRECT Q-GARD PACK	The System does not recognise the type of Q-Gard Pack being installed. Contact Millipore.
INCORRECT QUANTUM CARTRIDGE	The System does not recognise the type of Quantum Cartridge being installed. Contact Millipore.
MILLI-Q FEED C > MAX	The feedwater conductivity is out of measurement range. Contact Millipore.
MILLI-Q FEED T < MIN	The feedwater temperature is out of measurement range. Contact Millipore.
MILLI-Q FEED T > MAX	The feedwater temperature is out of measurement range. Contact Millipore.
MILLI-Q INTER R > MAX	The Intermediate resistivity is out of measurement range. Contact Millipore.
MILLI-Q INTER T < MIN	The Intermediate temperature is out of measurement range. Contact Millipore.
MILLI-Q INTER T > MAX	The Intermediate temperature is out of measurement range. Contact Millipore.
MILLI-Q RES < SP, REPLACE Q-GARD AND QUANTUM	The Milli-Q Water resistivity is < set point. Dispense water to eliminate any trapped air in the System. Replace the Q-Gard Pack and the Quantum Cartridge.

Continued on next page

Summary of Alarm messages, Continued

Alarm messages
(continued)

LCD message	What it means
MILLI-Q RES > MAX	The Milli-Q Water resistivity is out of measurement range. Contact Millipore.
MILLI-Q T < MIN	The Milli-Q Water temperature is out of measurement range. Contact Millipore.
MILLI-Q T > MAX	The Milli-Q Water temperature is out of measurement range. Contact Millipore.
POD LOCKED	The POD Unit microswitch is locked. Push the Plunger all the way down and release.
Q-GARD PACK OUT	The Q-Gard Pack is not installed correctly or it has been removed. The System stops operating. Verify that the Q-Gard Pack is installed correctly. Contact Millipore if the problem continues.
QUANTUM CARTRIDGE OUT	The Quantum Cartridge is not installed correctly or it has been removed. The System stops operating. Verify that the Quantum Cartridge is installed correctly. Contact Millipore if the problem continues.
TANK EMPTY	The System has detected an empty Reservoir. Refill the Reservoir. Verify that the Reservoir level sensor is plugged into the System Cabinet.
WATER DETECTED	A Water Sensor (an accessory connected to the System) has detected water. The System stops operating. Clean up the spilled water. Make sure the source of the leak is fixed.

Alerts

Overview

Introduction The purpose of this chapter is to explain the Alert messages shown on a System.
Specifically, this chapter explains how:

- an Alert message is displayed,
- to read an Alert message,
- to cancel an Alert, and
- a list of Alert messages is shown.

Contents This chapter contains the following topics:

Topic	See Page
Alert information	82
Summary of Alert messages	87

Alert information

Purpose An Alert message corresponds to a maintenance request. Most of the Alert messages are related to the replacement of a consumable.

Types The following table summarises the different types of Alert messages.

Type	Description
Minor Alert	A minor alert message indicates that a maintenance action is needed within a number of days.
Major Alert	A major Alert message corresponds to an immediate maintenance request.

Examples An example of a minor alert message would be REPLACE POD PAK IN 15 DAYS.
An example of a major alert message would be REPLACE POD PAK.

Main Display An Alert message is shown on the bottom of the Main Display. In this example, the Alert message REPLACE POD PAK scrolls across the bottom of the LCD.

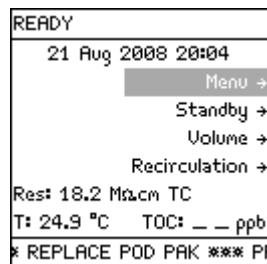

The yellow LED is lit steadily when an Alert message is shown. However, if an Alert and an Alarm are both present, then only the red LED is lit. When an Alert is shown, it is listed under the System Alerts LCD. To access the System Alerts LCD, see the Section View Operation.

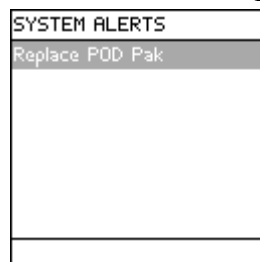







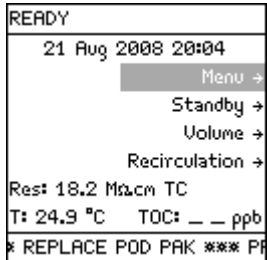

Continued on next page

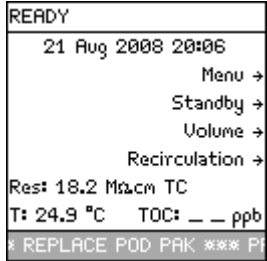
Alert information, Continued

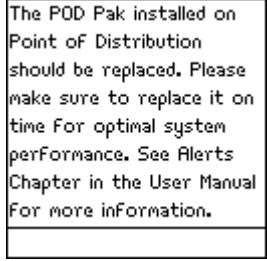
Viewing an Alert Message

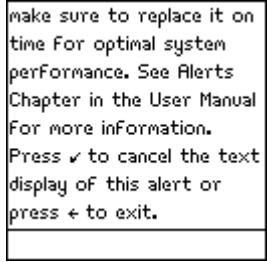
Follow the steps below to view an Alert message.

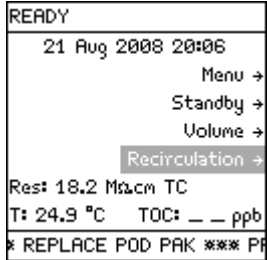
Step	Action	Diagram
1	Start in either READY or STANDBY Mode.	 <p>READY 21 Aug 2008 20:04 Menu → Standby → Volume → Recirculation → Res: 18.2 MΩcm TC T: 24.9 °C TOC: — ppb * REPLACE POD PAK *** PF</p>
2	Press  .	 <p>READY 21 Aug 2008 20:06 Menu → Standby → Volume → Recirculation → Res: 18.2 MΩcm TC T: 24.9 °C TOC: — ppb * REPLACE POD PAK *** PF</p>
3	Press  .	 <p>The POD Pak installed on Point of Distribution should be replaced. Please make sure to replace it on time for optimal system performance. See Alerts Chapter in the User Manual for more information.</p>
4	Press  .	 <p>make sure to replace it on time for optimal system performance. See Alerts Chapter in the User Manual for more information. Press ✓ to cancel the text display of this alert or press ← to exit.</p>
5	Press  .	 <p>READY 21 Aug 2008 20:06 Menu → Standby → Volume → Recirculation → Res: 18.2 MΩcm TC T: 24.9 °C TOC: — ppb * REPLACE POD PAK *** PF</p>

Continued on next page

Alert information, Continued

Cancelling a Minor Alert message - procedure

A Minor alert message can be cancelled by:

- performing the maintenance action (i.e. replace consumable),
- using the Keypad (see below), or
- a Major Alert message is shown. This eliminates the Minor Alert message.

Example: Before cancelling, the Minor Alert message is <Replace POD Pak in 15 Days>.

Main Display	LEDs	Main Display
<pre> READY 21 Aug 2008 20:09 Menu → Standby → Volume → Recirculation → Res: 18.2 MΩcm TC T: 24.9 °C TOC: _ _ ppb * REPLACE POD PAK IN 15 D </pre>		<pre> SYSTEM ALERTS Replace POD Pak in 15 days </pre>

Follow the steps below to cancel a Minor Alert message.

Step	Action	Diagram
1	Press	<pre> READY 21 Aug 2008 20:09 Menu → Standby → Volume → Recirculation → Res: 18.2 MΩcm TC T: 24.9 °C TOC: _ _ ppb * REPLACE POD PAK IN 15 D </pre>
2	Press	<pre> The POD Pak installed on Point of Distribution should be replaced in 15 days. Please make sure to replace it on time for optimal system performance. See Alerts Chapter in the User Manual </pre>
3	Press	The display of the Minor Alert is cancelled.

Continued on next page

Alert information, Continued

Minor Alert - after cancelling The Alert message has been cancelled but the cause of the message is still active.

Main Display	LEDs	Main Display
<pre> READY 21 Aug 2008 20:20 Menu → Standby → Volume → Recirculation → Res: 18.2 MΩ/cm TC T: 24.9 °C TOC: _ _ ppb </pre>		<pre> SYSTEM ALERTS Replace POD Pak in 15 days </pre>

Minor Alert - consumable replaced The Alert message has been cancelled when the A10 Lamp has been replaced.

Main Display	LEDs	Main Display
<pre> READY 21 Aug 2008 20:20 Menu → Standby → Volume → Recirculation → Res: 18.2 MΩ/cm TC T: 24.9 °C TOC: _ _ ppb </pre>		<pre> SYSTEM ALERTS No Alerts </pre>

Cancelling a Major Alert message - procedure

A Major Alert message can be cancelled by:

- performing the maintenance action (i.e. replace consumable), or
- using the Keypad. This cancels the display of the Major Alert message for 24 hours.

Example: Before cancelling, the Major Alert message is <Replace POD Pak>.

Main Display	LEDs	Main Display
<pre> READY 21 Aug 2008 20:21 Menu → Standby → Volume → Recirculation → Res: 18.2 MΩ/cm TC T: 24.9 °C TOC: _ _ ppb * REPLACE POD PAK *** PF </pre>		<pre> SYSTEM ALERTS Replace POD Pak </pre>

A Major Alert message can be cancelled using the Keypad. This is done in the same way that a Minor Alert message is cancelled. The display of the Major Alert is cancelled for 24 hours. It appears again after 24 hours unless the maintenance action is performed.

Continued on next page

Alert information, Continued

Major Alert – after cancelling The Alert message has been cancelled but the cause of the message is still active.

Main Display	LEDs	Main Display
<pre> READY 21 Aug 2008 20:21 Menu → Standby → Volume → Recirculation → Res: 18.2 MΩcm TC T: 24.9 °C TOC: -- ppb </pre>		<pre> SYSTEM ALERTS Replace POD Pak </pre>

Major Alert - consumable replaced The Alert message has been cancelled when the POD Pak has been replaced.

Main Display	LEDs	Main Display
<pre> READY 21 Aug 2008 20:21 Menu → Standby → Volume → Recirculation → Res: 18.2 MΩcm TC T: 24.9 °C TOC: -- ppb </pre>		<pre> SYSTEM ALERTS No Alerts </pre>

Summary of Alert messages

Alert messages

LCD message	What it means
CALIBRATION VISIT OVERDUE XX DAYS	The System has determined that a Calibration Visit is overdue. Contact Millipore.
CHECK UV 185 NM LAMP	The UV 185 nm Lamp is not turning on. Contact Millipore.
EXAMINE INLET STRAINER	The System has determined that it is time to clean the Inlet Strainer. Clean the Inlet Strainer and reset the message.
MILLI-Q FEED CONDUCTIVITY > SP	The measured feedwater conductivity is > Set Point. Check the source of feedwater and its conductivity.
MILLI-Q INTERMEDIATE RESISTIVITY <SP, PLEASE ORDER Q-GARD AND QUANTUM	The measured resistivity after the Q-Gard Pack is < Set Point. The Q-Gard Pack and Quantum Cartridge are replaced together. Contact Millipore about ordering a replacement Q-Gard Pack and Quantum Cartridge.
NEXT CALIBRATION VISIT IN XX DAYS	The System is prompting you that a Calibration Visit should be scheduled. Contact Millipore.
NEXT QUALIFICATION VISIT IN XX DAYS	The System is prompting you that a Qualification Visit should be scheduled. Contact Millipore.
NEXT SERVICE VISIT IN XX DAYS	The System is prompting you that a Service Visit should be scheduled. Contact Millipore.
NO RESPONSE FROM DHCP SERVER	Contact your network administrator. Restart the System.
QUALIFICATION VISIT OVERDUE XX DAYS	The System has determined that a Qualification Visit is overdue. Contact Millipore.
REPLACE POD PAK	The System has determined that the POD PAK needs replacement. Replace the POD Pak and reset the timer.
REPLACE POD PAK IN XX DAYS	The System has determined that the POD PAK should be replaced in XX days, where XX is 15, ..., 1. Replace the POD Pak and reset the timer.

Continued on next page

Summary of Alert messages, Continued

Alert messages (continued)

LCD message	What it means
REPLACE Q-GARD PACK	The System has determined that the Q-Gard Pack should be replaced. Replace the Q-Gard Pack.
REPLACE Q-GARD PACK IN XX DAYS	The System has determined that the Q-Gard Pack should be replaced in XX days, where XX is 15, ..., 1. Replace the Quantum Cartridge.
REPLACE QUANTUM CARTRIDGE	The System has determined that the Quantum Cartridge should be replaced. Replace the Quantum Cartridge.
REPLACE QUANTUM CARTRIDGE IN XX DAYS	The System has determined that the Quantum Cartridge should be replaced in XX days, where XX is 15, ..., 1. Replace the Quantum Cartridge.
REPLACE UV 185 NM LAMP	The System has determined that the UV 185 nm Lamp should be replaced. Contact Millipore.
REPLACE UV 185 NM LAMP IN XX DAYS	The System has determined that the UV 185 nm Lamp should be replaced in XX days, where XX is 15, ..., 1. Contact Millipore.
SERVICE VISIT OVERDUE XX DAYS	The System has determined that a Service Visit is overdue. Contact Millipore.
THE NETWORK CABLE IS UNPLUGGED	Check the Ethernet Cable plugged into the System and the computer. Restart the System.
THIS IP ADDRESS IS ALREADY USED BY ANOTHER SYSTEM	Contact your network administrator. Restart the System.

Ordering Information

Consumables, Accessories and Systems

Consumables

Item	Catalogue Number
BioPak Ultrafilter	CDUFBI001
Millipak Express [®] 40 Final Filter	MPGP04001
EDS-Pak [®] Final Filter	EDSPAK001
EDS-Pak Installation Kit - ordered 1 time only for multiple EDS-Pak uses.	EDSKIT001
Q-Gard T1 Pack	QGARDT1X1
Q-Gard T2 Pack	QGARDT2X1
Q-Gard T3 Pack	QGARDT3X1
Quantum TEX Cartridge	QTUM0TEX1
Quantum TIX Cartridge	QTUM0TIX1
UV 185 nm Lamp	ZMQUVLP01

Accessories

Item	Catalogue Number
Cabinet Wall Mounting Bracket	WMBSMT002
Feedwater Conductivity Cell	ZFC0NDCL1
Footswitch (for Remote POD)	ZMQSFTS01
Pressure Regulator	ZFMQ000PR
Remote POD	ZMQSP0D02
Remote POD Wall Mounting Bracket	WMBQP0D01
Water Sensor	ZFWATDET4

Continued on next page

Consumables, Accessories and Systems, Continued

**Milli-Q
Reference
System**

Item	Catalogue Number
Milli-Q Reference Cabinet	Z00QSV001

NOTE:

A complete Milli-Q Reference System consists of a:

- Milli-Q Reference System Cabinet, and
- Q-Gard Pack, Quantum Cartridge and POD Pak.

Note

Regularly scheduled preventive maintenance/calibration will help you obtain the best performance from your Millipore water purification system throughout its entire lifetime.

Please contact your Millipore representative to find the best options for your system including our maintenance programs.
